



Campus Master Plan

Texas A&M University at Galveston
Mitchell Campus

Ford, Powell & Carson Architects & Planners, Inc.

Campus Master Plan

Texas A&M University at Galveston
Mitchell Campus

Donated to the University by George P. Mitchell '40

April 2009
Ford, Powell & Carson Architects & Planners, Inc.

This document, dated April 23, 2009,
approved by Boone Powell (registration
number 2863-9) is not intended to be
used for regulatory approval, permit, or
construction.

Table of Contents

Campus Master Plan

A. Physical Master Plan

CEO's Introduction	A.1
Introduction and Summary	A.3
Master Plan Goals	A.5
Campus Character	A.7
Campus Master Plan	A.9
Campus Entrance	A.11
Spaces: Central Plaza	A.13
Spaces: Ship's Green	A.19
Spaces: Basin and Waterfront	A.21
Pedestrian Walkways and Bike Routes	A.23
Campus Zones	A.27
Academic and Research Facilities	A.29
Housing	A.31
Recreational Facilities	A.33
Other Areas	A.35
North Physical Plant and Utility Corridors	A.37
Roadways and Parking	A.39
Phasing	A.41
Cost	A.43

B. Design Guidelines

Introduction	B.1
Colors and Materials	B.3
Building Shapes and Forms	B.5
Glazing and Shading	B.7
Walkways and Plazas	B.9
General Hardscape	B.11
Landscape	B.13
Signage and Identification	B.21
Harbor and Roads	B.23
Exterior Lighting	B.25
Environmental Considerations	B.27
Disaster Readiness	B.31

C. Technical Report

Introduction	C.1
Wayfinding and Signage	C.3
Electrical Systems	C.33
Thermal Energy	C.35
Water, Sewer, and Stormwater	C.37
Telecommunications	C.41

Acknowledgements

CEO's Introduction



When I rejoined Texas A&M University at Galveston in May, 2005, one of my first requests was for a copy of the current master plan for the university. There were actually two such documents — a conceptual plan which had been developed for the Teichman Campus, and a second, complete master plan, for the Mitchell Campus on Pelican Island. What immediately struck me was that neither plan had been followed as construction and landscaping was done in the years subsequent to the plans' completion.

Based on this observation, the principal concern that I voiced in 2008 as we began to discuss a new master plan for the Mitchell Campus was that it be a plan we could actually use to guide future decisions on new building locations, on making the campus more livable and attractive, and on accommodating expected growth.

During this same time period I had several conversations with Mr. George P. Mitchell, a long-time supporter of both Texas A&M University and its Galveston branch campus, about the vision for the Mitchell Campus. Since the Mitchell Campus on Pelican Island started from a gift of land from Mr. Mitchell, he was clearly interested in the future development of the campus. Ultimately, he agreed to fund a master plan for the Mitchell Campus and present it to us as a gift.

At this point we had a guiding principle, and we had the financial wherewithal to actually create the plan. Also, thanks to Mr. Mitchell, we had a design firm, Ford, Powell & Carson, Inc. of San Antonio. In particular, our planning effort would be led by Boone Powell, with Jay Loudon as the principal staff support.

From the beginning, we wanted strong input from all components of the university community — the faculty, students, staff, and administration. Many, many meetings were held to obtain ideas and reactions from those who would literally live with the plan as it was implemented. Boone and Jay pored over data that charted our past and predicted our future. Just as the plan was taking final shape, Hurricane Ike struck Galveston Island and resulted in a six-month delay in the planning process.

In spite of the delay, the development of the Mitchell Campus Master Plan is now complete. As Texas A&M University at Galveston accelerates its growth in student enrollment, educational programs, and research involving the oceans and the Texas coast, this new plan will guide us in making the best use of the land given to us by George P. Mitchell. Moreover, the plan provides the necessary basis for developing priorities in renovation, expansion, and new building construction. Finally, the plan will help us in providing our students, faculty, and staff with an attractive and livable campus. The plan that has emerged is exciting and charts the future of Texas A&M University at Galveston as a world-class, ocean and coastal research, training and educational institution for decades to come. Our thanks go out to all those at Ford, Powell & Carson who contributed to its development and to all the Sea Aggies who provided their advice and counsel. Most of all, we are deeply appreciative of Mr. Mitchell's generous gift, and we are eager to turn this new master plan into reality.

A handwritten signature in black ink, appearing to read "R. Bowen Loftin". The signature is fluid and cursive, with a long horizontal stroke extending to the right.

R. Bowen Loftin, Ph.D.
Vice President and Chief Executive Officer
Texas A&M University at Galveston

Texas A&M University at Galveston (TAMUG), a Texas A&M University campus, conducts specialized research and academic programs in marine sciences and maritime-related fields. The university is home to the Texas Maritime Academy, one of six academies in the United States which prepare students for licensing as officers in the United States Merchant Marine, and to the training ship Texas Clipper III.

This master plan addresses physical planning issues at the Mitchell Campus, which is the main campus of TAMUG. It was commissioned by George P. Mitchell, a long-time benefactor of Texas A&M and a life-long Galvestonian. At Mr. Mitchell's behest, one of the primary issues which this master plan focuses on is the character of the campus; the existing campus has little connection to the university's important marine-related research programs, its technologically-advanced maritime studies, or its wetlands-surrounded setting on a coastal barrier island.

Growth projections for the university indicate that the campus population will swell in coming years. This master plan is targeted for a twenty-year period ending in 2028. The student population will grow from just over 1,600 in 2007 to 3,000 in that time. As of the time of this writing, 2008, the university has already seen growth to above 1,700 students. Accommodating that growth will mean a doubling of many campus facilities and construction of new types of facilities which the campus does not currently have.

The development of this master plan included meetings with students, faculty, TAMUG administration, and Texas A&M administrators. Various alternative plans (see illustrations) were developed, and the plan presented here is a composite of several alternates.

A master plan is only as good as its implementation. The university will encounter difficulties as it expands to accommodate projected growth, and it faces challenges even now in the form of outdated and insufficient facilities. It is important to not lose sight of the destination amid these challenges; expedient solutions are frequently harmful in the long term.



Waterfront



Schematic alternate 1



Schematic alternate 2



Schematic alternate 3

Introduction and Summary



Rendering



Aerial view of campus



Future pedestrian spines and gathering places

Summary

- Design guidelines set out in this document call for buildings, landscaping, and plaza developments which will create a character for the university which is in tune with its setting, programs, and mission
- Future developments will focus attention and activity on the waterfront in order to build on one of the campus's strengths
- Refinements and changes to the main campus open spaces, notably the central plaza and the Ship's Green, will strengthen the ceremonial, visual, and symbolic centers of the campus
- Five new academic/research buildings, totalling over 400,000 gross square feet, will be required
- Housing capacity will grow commensurately with the growth of the university, requiring about 1,500 beds
- The campus will increase somewhat in density so that the campus is a more pedestrian-friendly, walkable place
- Land will be set aside for a natural reserve along the western shoreline
- An area has been designated for a technology development area, where incubator facilities for public-private partnerships will be built
- A series of utility corridors, a new physical plant, and other infrastructure changes will renovate the university's deteriorating core and will enable growth to the planning horizon and beyond

Create a place-appropriate character for the university

- Incorporate design elements, principles, and materials which are appropriate for a maritime university
- Create meaningful relationships between the campus and the waterfront and locate nodes of activity on the waterfront
- Establish guidelines for design which incorporate current campus design elements while reflecting a new, maritime-oriented character
- Use landscape materials to form well-scaled spaces and plazas and to soften campus architecture



Galveston coast



Sail-like building construction

Accommodate future growth

- Plan for facilities growth according to THECB standards
- Expand and locate parking appropriate for future needs
- Locate new sites for campus housing and other activities which will enhance campus life

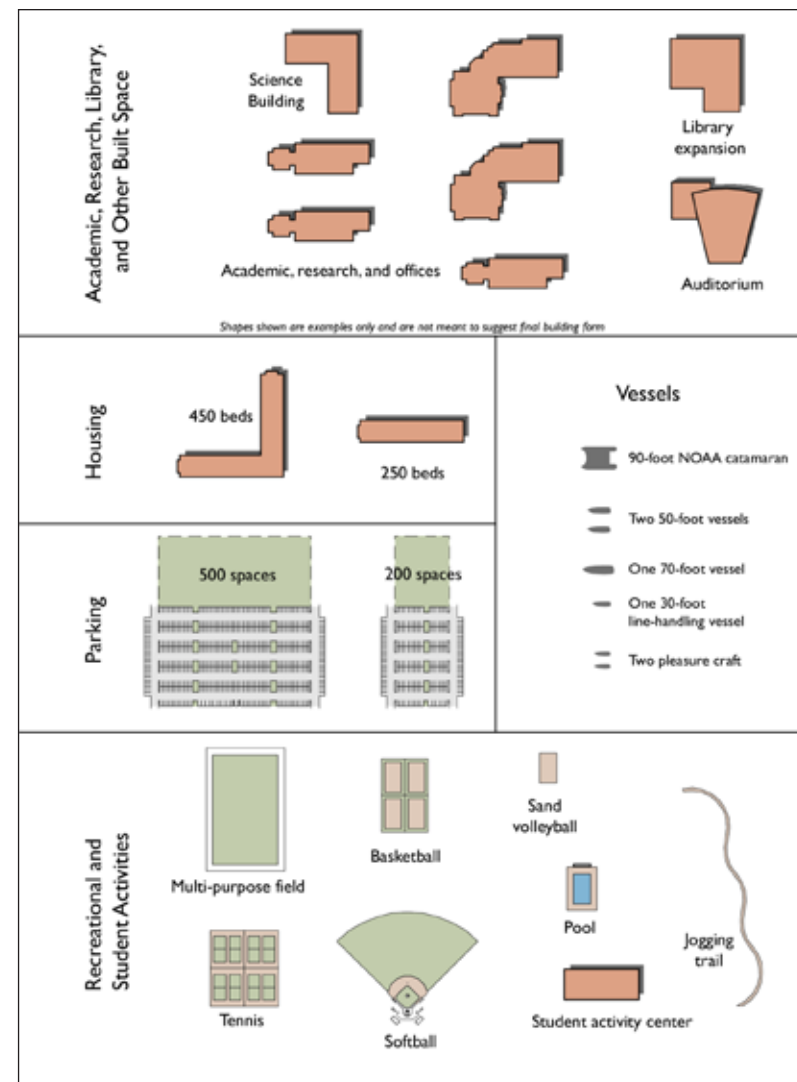

Additional facility requirements for 3,000 students

Master Plan Goals

Improve the basic campus environment

- Create a more pedestrian-friendly campus
- Renovate and expand aging utility infrastructure
- Build sustainable, energy-efficient buildings and infrastructure
- Improve wayfinding and signage
- Incorporate art and hand-crafted elements to humanize the campus environment



View of Kirkham Hall from the Texas Clipper



Sculpture by James Surls

Goals for the master plan were generated through discussions with university representatives. These goals are effectively checkpoints for progress; building and landscape projects should be assessed against these points to ensure that completed projects further progress towards accomplishing the master plan as a whole.

- Communicate these goals, the master plan, and the design guidelines to the design team of each project to ensure that they are aware of them
- Assess each project for compliance with these goals, the master plan, and the design guidelines
- Review these goals on a regular basis to ensure that they still correspond to the university's intentions



Texas Clipper III



Bollard



Flags, pennants, masts, and sails



Marshes and coast

Campus Character

Great universities – and great places in general – have characters which are exceptional to those places. That character is inevitably particular to the history, geography, and culture which have shaped it. TAMUG possesses the building blocks to become a unique and great institution in the ways in which its programs, its mission, and its location interrelate. This master plan addresses a variety of topics, from the mundane to the exceptional, but each individual component of the plan is intended to establish, buttress, and finally achieve the singular goal of building a campus which has a character that is exemplary of the Aggie spirit, the university's mission, and its connection to the sea.

The character of a place is not created absent impetus. Character is not a matter of the application of ornament or decoration. Rather, character reveals the genius – that is, the uniquely identifying spirit – of a place. Character is generated by the ebb and flow of the rituals, rhythms, and motivations which lie beneath the superficial moment-to-moment activity of a place. The simple act of a student carrying a fishing pole to the shore to fish is as plain as it sounds on the surface, yet it is also a marker of the university's character: the location of the campus, interests of the student body, and relationship to the sea are the underlying generator of the activity. Such a simple act can resonate deeply with the residents of a place because it is an identifier of the unique character of that place.

What, then, is the role of the master plan in this process? A master plan is not like a building project – it is concerned with encompassing concepts, whether they are campus utility infrastructure or student traditions, rather than more specific requirements. A master plan should define for designers what the important elements of character are which define the place and which should be reinforced in building projects.



Rib-like building elements

- Give people ways to occupy the waterfront
- Build informal programs around the sea and the wetlands
- Create campus architecture and outdoor spaces which relate specifically to the spirit of the university
- Use blue, green, gray, and white colors, with salmon accents, to reinforce connections to the sea and waterfront architecture
- Reference design elements of naval architecture in new buildings
- Allude to Galveston waterfront architecture in new construction
- Commission marine- and maritime-related sculpture for selected outdoor spaces
- Use flags, banners, and other colorful, moving elements to create activity and interest



Campus Master Plan
Texas A&M University at Galveston

0 200

April 2009

Ford, Powell & Carson Architects & Planners, Inc.

Master Plan



Existing campus plan (2008)



Aerial rendering

1	Mary Moody Northern Student Center
1a	Student Center Expansion 1
1b	Student Center Expansion 2
2	Williams Library
3	Classroom-Laboratory Building
4	Administration Building
5	Auditorium
6	Kirkham Hall
7	Electrical Service
8	Sewer Plant
8a	Sewer Plant Addition
9	Marine Engineering Research Complex
10	Marine Transportation Building
11	Academic/Research Building A
12	Academic/Research Building B
13	South Physical Plant
14	Harbor Pavilion
15	Waterfront Storage/Office
16	Texas Clipper III
17	Main Dock
18	Boat Basin
19	Science Building
20	Academic/Research Building C
21	Academic/Research Building D
22	Academic/Research Building E
23	Physical Education Building
23a	PE Building Addition
23b	PE Building Addition
24	North Physical Plant, Receiving and Operations
25a	Ocean Hall
25b	Hullabaloo Hall
26	Residence Life Center
27	Residence Hall A
28	Residence Hall B
29	Residence Hall C
30	Residence Hall D
31	Residence Hall E
32	Residence Hall F
33	Student Apartments
34	Student Activity Center
35	Married Student Housing
36	Athletic Fields and Recreation Facilities
37	Wetlands Pavilion
38	Off-Campus Housing
A	Ship's Green and Corps Platform
B	Central Plaza
C	Pool Commons
Additional Existing Plan Buildings	
39	Student Support Building
40	Sea Aggie Center
41	Oceanography Building
42	Mariner Hall



Campus Entrance



Plan of entrance



Current entrance alignment and view

The entrance is one of the most important visual features of the campus. Because of its visual prominence, it is invariably the primary destination for visitors and prospective students, regardless of where their actual destination may be, and so is very important in creating first impressions.

- Retain the entrance where it is currently located, but re-design and develop it so that it is more prominent
- Build an entrance structure which will be visible from the bridge in order to emphasize the entrance
- Align the north loop roadway (which accesses the land across Seawolf Parkway) with the main entrance and signalize the intersection
- Build a parking lot at the entrance which will be dedicated to people who are visiting the administration offices or the student center
- Line the entrance boulevard with trees to provide shade and visual reinforcement
- Locate functions and facilities which are oriented towards visitors (reception areas for prospective students, information desks, and campus tour gathering places, for example) near the new campus entrance and parking
- Using the new parking as a starting point, create clearly signed pathways to the most-frequently used visitor-oriented facilities



Central plaza

The student center is projected to expand in several phases throughout the duration of the master plan. The first phase, which will include primarily offices, will be in the range of 8,000 gross square feet. An additional phase will expand the food service capacity of the student center.

One of TAMUG's most glaring space deficiencies is library space. Current needs are for over 44,000 square feet according to the THECB model. This situation will obviously get worse as the student population grows. Additionally, the proportion of graduate students will increase in the future, and they require even more library space per student than undergraduates.

That said, the THECB model has not kept pace with the changing role of the library in today's universities. Access to online materials has become of primary importance; traditional physical collections will remain important, but more space is being dedicated to electronic access.

Additionally, libraries have become gathering places and study centers for students. Most offer wireless internet access, and as the amount of online material used in courses increases, students have increased their use of libraries as places to gather and work on homework and group assignments. Many libraries now offer numerous dedicated group study rooms, rather than the individual study carrels and limited group rooms of years past, and allowing students to bring food and drink to those rooms has become common. A new model is emerging of libraries as social centers based on these new patterns of usage.

The net effect of these changes is that, if anything, libraries require more space than before in spite of the declining footage dedicated to stacks and reference materials. TAMUG's library is well placed in the center of campus, next to the Student Center, and a transition to the new library model will work well. A large addition is shown next to the current library. It should share an entrance with the existing library and should be two stories in order to provide the required space.

Spaces: Central Plaza



Elizabeth and Searcy Bracewell Clock Tower



Double row of trees

The heart of TAMUG's campus is the plaza surrounded by the library, the student center, and the Classroom Lab Building. The plaza has great potential in this role, but it is currently overscaled and offers little respite from the sun. Future buildings and additions around the central plaza will solve both those issues as well as accommodate future growth.

- Expand the student center in two phases and incorporate uses which are currently in the Sea Aggie Center. The student center should be a one-stop operation with all student services in one place. Explore the possibility of incorporating a health clinic into the center.
- Expand the library to meet current needs. Re-investigate the role of the library and incorporate different types of facilities to better accommodate the needs of students.
- Build a 500-600 seat auditorium for lectures, student performances, and general usage. Explore creating flexible spaces which can be combined with the main auditorium space in order to create a single, larger space for major events. Locate sufficient parking and drop-off spots nearby.
- Build a dedicated administration building and centralize top leadership there. Ensure easy access for visitors by locating a visitor parking lot nearby.
- Line the plaza with trees, similar to the double row of trees at the Classroom Lab Building

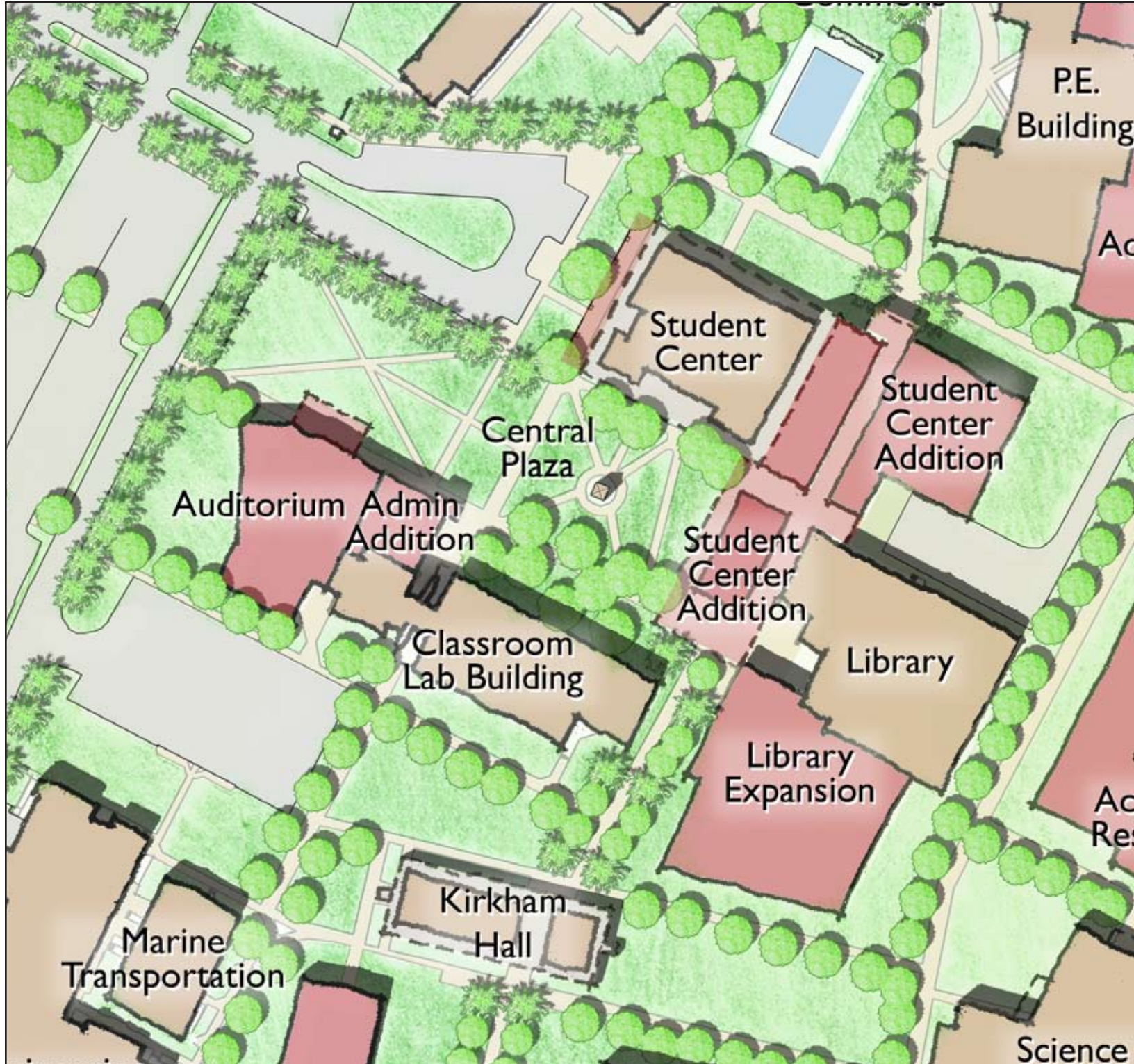

Central plaza site plan

Spaces: Central Plaza



Library entrance



Aerial rendering of campus center

Library Expansion

TAMUG's library does not have sufficient space to satisfy current needs. It is well located – in the heart of campus – but it will need to be significantly expanded and its role updated to better meet the needs of current and future students.

- Expand the library to act as a social center, including group study space and food service
- Grow the library immediately to meet current needs
- Investigate new methods of using library resources to relate to students
- Use the existing library entrance to serve the addition

Student Center Expansion

- In the first phase, expand the student center into the plaza in order to provide protected walkways and mediate the scale of the plaza
- In the second phase, expand the student center east and create a walkway between the existing building and the addition
- Combine the various student services now located in the Sea Aggie Center with those in the current student center
- Consider incorporating student health services into the student center as the student population grows



Auditorium and administration addition

TAMUG needs a large space for lectures, orientations, student performances, and other gatherings. The footprint shown for the auditorium is sufficient for a building which can seat 400 to 500 people. This is not large enough to seat the entire student body, nor should it be. As TAMUG grows, very large events must be split into multiple sessions or held in alternate venues. The auditorium should not be sized for the very largest campus events; it should be sized for the largest number of campus events. However, during the design of the facility, a number of techniques should be explored to allow the basic capacity of the auditorium to be augmented for overflow events, such as flexible spaces near the auditorium which can be combined with the main space.

Because invited lectures and performances often draw members of the general public, the auditorium should have easy access from vehicular drop-offs so that disabled and elderly visitors can be dropped off nearby. The visitor parking and entrance circle is located just across the plaza from the auditorium and is a natural location for this use. Additional parking is located to the west and south of the building.

TAMUG has limited space currently dedicated to administration – many administrators also teach, and the need to be located near academic departments generally overrides the advantages offered by a building dedicated exclusively to admin-

Spaces: Central Plaza



Aerial rendering of auditorium and surrounding area

istration. Whether or not this situation changes in the future, TAMUG has a sufficiently large administration to merit a dedicated building or wing.

The Administration Addition will be located near the center of campus, on the central plaza. The visitor parking and entrance circle is just to the north, so visitors will be able to access the building easily from the main entrance. The location of the addition on the central plaza is also important symbolically – it is important for the administrative functions of the university to be represented, together with the student center, library, and the academic functions of the CLB, in the heart of campus.

The addition is shown abutting the large lecture theater in the CLB. Construction of the addition will create an opportunity to rework the hardscape at the entrance to the CLB near the lecture theater in order to allow pedestrians to enter directly from the north and south rather than being forced to navigate around the walls currently located at that entrance.

Auditorium

TAMUG will need a gathering space for lectures, performances, and similar events. The auditorium will be located on the central plaza and will hold 400 to 500 people.

- Build an auditorium to serve the majority of needs, not for the largest events, but explore ideas to allow the flexible expansion of the hall when necessary
- Site the auditorium so that visitors have easy access
- Design the facility to be flexible and useful for a variety of uses

Administration Addition

Although administrative offices are currently scattered throughout campus, as TAMUG grows, a dedicated administrative building may become useful.

- Dedicate space to administration to centralize personnel
- Place the facilities so that visitors can easily access them
- Locate the administrative building on the central plaza
- Use the administration building project to solve access issues at the Classroom Lab Building



Ship's Green and new academic/research facilities

The space called the Ship's Green in this master plan, between Kirkham Hall and the Texas Clipper, has the potential to become an important ceremonial space. The ship should be a primary focus of the campus, in both figurative and literal senses. As the space is now, the buildings on the east and west sides of the green are too far away and too discontinuous to form a strong axial space. The master plan shows the construction of two new buildings, both to be academic/research facilities, which shape and define the space much more clearly.

The Corps drill platform should be located in the end of the Ship's Green closest to the Texas Clipper. This position will reinforce the connection between Corps activities and the ship.



Aerial rendering of Ship's Green

Spaces: Ship's Green



Site plan of the Ship's Green

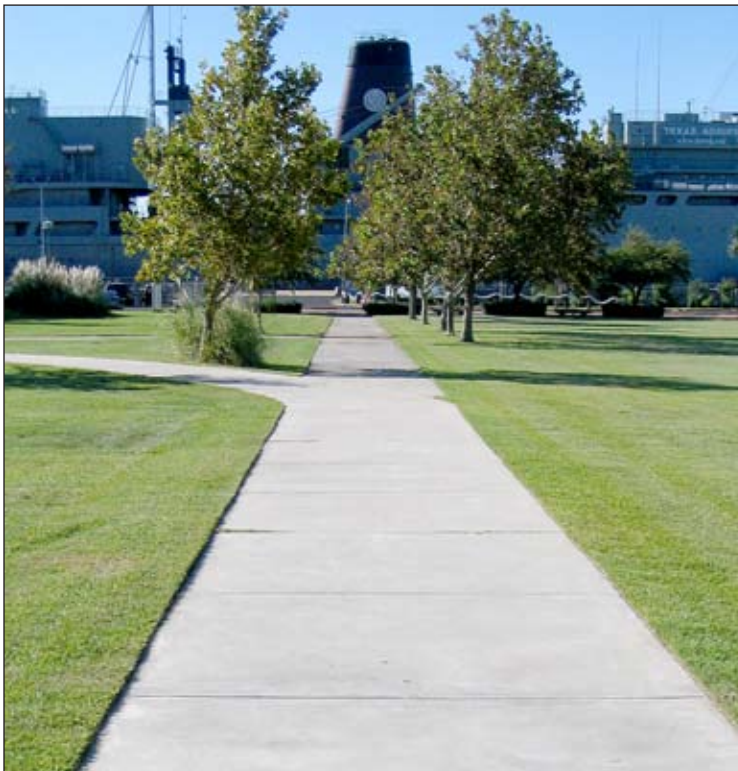

View of Texas Clipper III from near Kirkham Hall

In spite of the tradition-oriented character of Texas A&M and especially the Corps, the campus does not have any significant spaces for ceremonial activities. The Ship's Green – the space between Kirkham Hall, Texas Clipper, and the buildings on both sides – offers a place for those activities.

- Use the space between Kirkham and the training ship for ceremonies, drills, and other functions
- Build new buildings on the east and west sides of this space to create a more appropriate scale for the space
- Locate the Corps drill platform in the south end of the green, close to the Texas Clipper



Gathering space and boat basin

As with ports across the world, waterfront footage is a precious commodity at TAMUG. The university's current needs nearly fill the boat basin, leaving little room for additional vessels. Also, because of the size of Texas Clipper III, the pier has no extra capacity for another large vessel.

The existing pier may be rebuilt in the next five to ten years in order to strengthen it and to provide additional security for moored vessels in the event of adverse weather. While the area around the pier can be dredged and the pier can be somewhat lengthened (perhaps enough for a vessel 100 to 200 feet long) It is not likely that the pier can be significantly enlarged. Because additional large vessel docking capacity could benefit TAMUG, options for land acquisition or lease which would allow this should be investigated.

A second boat basin immediately east of the bridge would increase space available for small vessels considerably. This smaller facility could be dedicated for TMA vessels, or it could act in concert with the existing basin to accommodate a variety

of university boats. Expanding the existing boat basin would be difficult and costly. For these reasons, the master plan shows the basin remaining at its current size. Should funds become available for enlarging the basin, however, that work can be done without invalidating the master plan. It may become necessary to locate boats which are less critical to TAMUG's mission at other facilities if the need for slips for research and training vessels grows.

The boat basin is one of the centers for activity on the campus and is also, together with the waterfront and the training ship, potentially the most emblematic space at the university. As such, it should be used as a setting for events of all types. A permanent pavilion for events should be built here to serve as shelter. The master plan shows a space at the south end of the building along the east side of the Ship's Green for this use.

Spaces: Boat Basin and Waterfront



Storage buildings at the boat basin



Boat basin



Boat basins and pier

The boat basin and waterfront are integral parts of TAMUG's daily operations. They also offer some of the most interesting possibilities for gathering spaces. While the area currently serves TAMUG's operational needs adequately, additional investment in docking and servicing infrastructure and in spaces for events and gathering will serve the university well.

- Build an event space in the south end of the future building on the west side of the boat basin
- Construct a new basin on the west side of the waterfront, near the bridge, for use primarily by TMA
- Expand the existing boat basin if feasible, but make the best use of space in the interim
- Build a permanent facility (with multiple independently secured storage rooms, if necessary) for dockside storage and offices
- Reconstruct and enlarge the pier if and when possible
- Investigate possibilities for land acquisition which could increase docking capacity
- Relocate personnel and maintenance physical plant operations to the new physical plant to clear space for a new building site



Pedestrian paths and main campus open spaces

The campus's network of pedestrian walkways and open spaces are at the core of how people relate to the campus. It is important to locate and landscape walkways carefully. Many existing walkways on campus were poured once patterns of movement between various buildings had been established; this technique can be used for some of the lesser walkways shown in the master plan, but the main walkways should be located as shown.

The most heavily traveled walkway will be the one which runs from the training ship, through the center of campus, through the expanded student center, then north across Seawolf Parkway to future student housing. The eastern pedestrian



Main campus open spaces



North-south axes



East-west axes

spine, running from the boat basin to the east side of the housing on the north side of campus, will see greater use as the academic and research facilities north and east of the Science Building are constructed.

A significant portion of the campus's academic, research, and office expansion will occur east of the library. This area is close to the boat basin and is easily accessed through the north campus entrance. The eastern pedestrian spine will start at the boat basin and run north past the Science Building and library and will eventually connect to future housing and parking on the north edge of campus.

Pedestrian Walkways and Bike Routes



Pedestrian walkway



Campus walkways and parking lot locations

The spaces detailed in previous pages are only one component of the pedestrian network on the campus. The walkways which connect those open spaces are just as important. Amenities like benches, trash receptacles, landscaping, and shade are a vital part of the walkway system and should be built with the construction of each walkway. Existing walkways should receive similar treatment.

- North-south pedestrian spines will connect the campus to the waterfront and will be the primary walkways
- Walkways intersect at plazas and frequently enter at the edges of plazas rather than the center
- Walkways and plazas should both offer a variety of shaded and sunny spots; the amount of shade should generally be higher than it is currently
- Places to sit should be located along the walkways in both shade and sun
- Roads are located at the perimeter of campus so that they intersect walkways infrequently
- While dedicated routes for bicycles are not feasible throughout campus because of space limitations, portions of roadways and wide walkways can be used by bicyclists



Campus open spaces and axes

Pedestrian Walkways and Bike Routes



Campus walking times



Pedestrian walkway

- The main campus spine will run from the Texas Clipper, through Kirkham Hall, through the expanded student center, then north into the housing area across Seawolf Parkway
- The eastern pedestrian spine will become more important as research and academic facilities are built to the north and east of the boat basin
- East-west walkways will connect the three north-south axes
- Pedestrian walking times will remain short because of the small size and density of the campus
- A walkway/bicycle connection across the bridge to Galveston Island should be established, possibly using the former railroad right-of-way
- Racks for bicycles should be placed near building entrances and at various appropriate locations across campus, like near recreational fields and near gathering spaces
- Options for crossing Seawolf Parkway should be explored. These may include an on-grade signalized crossing with pavers or other material denoting the crossing and a depressed path which crosses underneath a slightly raised roadway. A bridge crossing Seawolf is not likely to be effective, as it would be quite expensive (elevators would be required) and would be ignored by most pedestrians due to the extra effort required.



Campus zones

Campus Zones



Academic and research



Housing



Recreation



Administration/Student Services



Shore Area Reserve



Physical Plant/Utilities



New facilities



Existing facilities

The existing campus is fairly efficiently zoned – different campus uses (academic/research, administrative/student services, housing, and recreation) are grouped together well. The master plan builds on this strength by maintaining the same groupings and relationships but increases the density of those zones to create a more walkable campus.

- Build academic and research facilities in the south portion of campus, especially near the waterfront.
- Move student service-related functions from the Sea Aggie Center to an expanded student center and build a dedicated building for administration
- Move recreational facilities to the north side of Seawolf Parkway where there is significant available land
- Expand housing across Seawolf Parkway to take advantage of proximity to recreational and student services functions



Waterfront academic/research facilities

Many of the academic and research programs at TAMUG require direct access to research vessels. Currently, only the new Science Building offers that access. In the future, though, the buildings shown on the master plan as Academic/Research Building 2 and Academic/Research Building 3 will have close relationships to the waterfront. Methods of enhancing the connections between the basin and research labs and classrooms should be explored, including roll-up doors, hardscape elements, and shading structures at the buildings. Such connections will serve not only university programs, but the image and character of the campus as well.

These two sites should be held specifically for buildings and programs which require waterfront access or which can benefit from proximity to the waterfront in specific ways. One of the main goals of this master plan is to strengthen campus connections to the waterfront. The single best way to do so is to place uses at the

waterfront which generate activity, and programs which need direct access to the waterfront are ideal for that. The sequence of demolition and construction may mean that one or both of these sites is available when more general academic programs need additional space; the temptation of using the best sites for the buildings at hand should be defended against. The rarity of these sites and their criticality to TAMUG's mission cannot be overstated.

The PE Building is a relatively new facility, and it serves the current needs of the campus well. It will not, however, be sufficient in the future. The building was planned for expansion, and one potential footprint for that expansion is shown on the master plan. Designers should consult with TAMUG to determine what the most important needs are when the facility is expanded.

Academic and Research Facilities

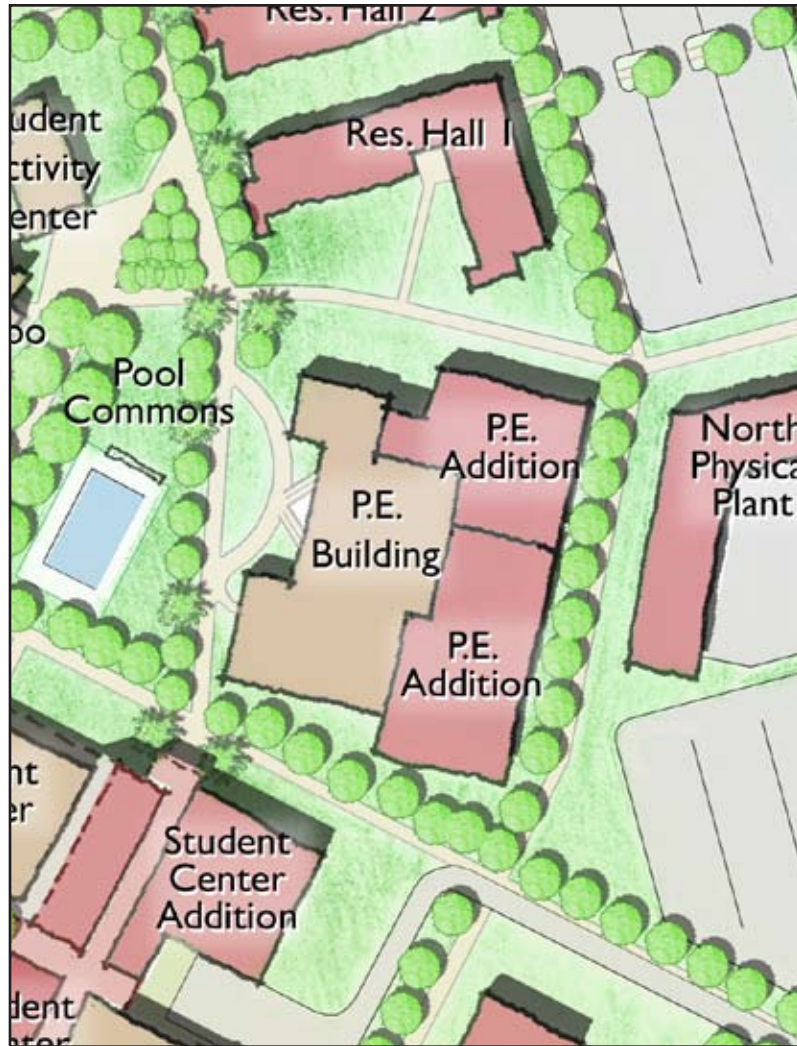

PE Building and additions

The PE Building's location near the housing yet also close to the heart of campus is ideal for its dual-purpose use as a recreational center and teaching facility. Scheduling these two uses together may become more difficult as the student population grows, so some duplication of facilities may be necessary. There is sufficient land around the building to allow for growth beyond what is shown in the master plan should it be necessary.

Waterfront Academic/Research Facilities

- Locate buildings and uses on the waterfront which can best make use of waterfront access
- Reserve waterfront sites for programs which need waterfront access
- Dedicate a portion of Academic/Research I to TMA

Physical Education Building

- Expand the PE Building in place to meet future needs
- Duplicate facilities for recreational and educational uses as necessary
- Capitalize on the location of the facility near both student housing and the academic core
- A student health facility may be incorporated into this facility in the future if this location is preferred to a location in the student center



Housing site plan

One of TAMUG's most significant current limitations is housing. There are over 600 beds located on campus in three dormitories, but 400 of those beds are in Mariner Hall, which is at the end of its useful life. Off-campus private dormitories located at the intersection of Seawolf Parkway and Texas Clipper Road supply additional housing, but they are not subject to TAMUG's housing rules and have been a source of trouble in the past. To maintain a similar proportion of housing beds to student population, there are a total of nearly 1,300 beds shown in the master plan.

New housing will be located both in the northern part of the existing campus and across Seawolf Parkway in the undeveloped land there. The placement of

this housing will establish an extension of the campus's central axis north into the undeveloped land.

It is important to clearly and compellingly establish this axis extension across Seawolf Parkway when new housing is built across the road. It will also be necessary to build a crosswalk at the point where the walkway crosses Seawolf. As discussed in the section on roadways, a median should be placed in the middle of Seawolf in order to give students crossing the road a landing place mid-way between the two sides. Striping in the road, or possibly an alternate paving material, should further designate the crossing point.

The construction of the dormitories should be staged so that the buildings closest to Seawolf Parkway are all built at the same time. Doing so will ensure that a significant number of students live across the road. It will then be possible to establish a community there, rather than merely having a single disconnected dormitory. Constructing some of the recreational facilities at the same time or before that housing is built will help add to the critical mass of students.

TAMUG has a diverse student body, and the choices offered for housing should be similarly diverse. The master plan shows various sizes of residence halls as well as apartment-type buildings. Different room types should also be offered, including singles and doubles.

The Texas Maritime Academy (TMA) is a special community within the larger campus community. Just as one of the goals of the master plan is to reinforce campus spirit, it is also important to enhance the sense of community surrounding the Corps of Cadets. Separate, dedicated housing is one way to do this.

Separating the Corps housing from general housing is also useful for functional reasons. Cadets are required to stand watches on the Texas Clipper and participate in other activities such as morning formation; schedules for these activities are generally very different from the schedules of non-Corps students, so separating the Corps housing will ease such conflicts. The location of this housing is also important; there should be direct pedestrian connections to the ship and the drill platform.

Consideration should be given to including a residence for a TMA faculty officer in the Corps housing. Having an officer present around the clock will strengthen ties between the TMA leadership and students.

Graduate and married student housing will also be located on the north side of Seawolf Parkway. It will be somewhat removed from the general student housing, as the older students and families who live in these apartment-like units desire some separation from the noise and activity of the general housing. It will be as close to the heart of campus as is the general housing, so students will be able to walk to class.

The number of units built in this complex should be determined by future overall demand. It may be necessary to fill open spots in the complex with people other than graduate or married students; if this is the case, consideration should be given to allowing faculty or upperclassmen to live here.

General Housing

- Retire Mariner Hall and use its site for more up-to-date housing
- Build diverse, university-controlled housing, including a mix of residence halls and apartment-style units; the mix can be varied from that shown on the master plan according to demand
- Build large residence halls on either side of Seawolf Parkway to establish a strong pedestrian crossing
- Build a critical mass of housing and recreation across Seawolf Parkway so that students there are not isolated
- Consider including a small satellite station for campus police in a new housing development across Seawolf

Corps Housing

- Dedicate housing to TMA, perhaps in the facility noted as Residence Hall I
- Consider including a faculty residence in the building
- Site Corps housing appropriately for TMA schedules and programs

Graduate/Married Student Housing

- Locate graduate/married student housing away from other housing but close enough so that students can walk
- Build apartment-like units
- Determine number of units by future demand



Recreational fields and student activity center

The campus is currently lacking in recreational facilities, and this situation will be exacerbated by growth. As the campus grows, sites in the campus core which are currently used for recreational purposes will be used for buildings, as the need to keep the academic areas dense is critical. Fortunately, the land across Seawolf Parkway is sufficient to accommodate all the recreational facilities which will be required as the campus grows.

The timing of the construction of the first fields and facilities across Seawolf Parkway is important. They should be in place when the first housing is built nearby, both so that it is available to those students and to reduce the isolation of the housing. In fact, construction of all new recreational facilities should occur across Seawolf Parkway in the areas shown in the master plan so that it does not need to be relocated when future buildings are built in the campus core. As the campus is currently deficient in housing, this construction should begin as soon as funding is available.

Recreational field locations

A small student activity center, similar to the one currently located near the dormitories, is shown near the recreational fields. One of the primary roles of this facility will be to support the recreational fields, so it should have storage space for equipment, showers and changing facilities, and a snack bar. The center should also have pool tables, a small movie theater, and other amenities as determined by the students. Construction of this facility will likely have to wait until the number of students in the vicinity is large enough to support it.

The number of fields shown assumes that they are lit so that they can be used into the evening hours. Lighting should be carefully placed and specified so that it does not create light problems for the dormitories to be located nearby. If fields are built before walkways have been established as part of housing development, consideration should be given to building a lit walkway in the alignment shown crossing Seawolf Parkway. The mix of fields and the order in which they are built should be determined by a programming effort prior to construction.

Recreational Facilities



Recreational fields and student areas

- Build recreational facilities soon to answer current demand
- Consider future housing when building fields on the north side of Seawolf Parkway
- Incorporate a student activity center when a sufficient amount of housing is built across Seawolf Parkway
- Light recreational fields so that they can be used in the evening
- Consider including a small satellite station for campus police in the new student activity center
- Coordinate construction of trails with physical fitness program requirements. Trail surface, length, and other features should accommodate academic program needs in addition to serving recreational uses.



Shore Area Reserve and Technology Development Center

TAMUG has a rare connection to the waterfront and the sea. While this connection is currently somewhat formless and without explicit character, it is present and is an opportunity to be enhanced. Previous master plans have shown significant development in the land north and west of Seawolf Parkway, and that development is in some cases quite inconsistent with the character of the land. This master plan shows a large area to the west of the existing campus which will be reserved in its current state for education, research, and recreation.

Most of Pelican Island, including all of the land on which TAMUG now sits, was created by dredged spoils. While the land is “natural” in that it has not been disturbed

by development, it is in fact of relatively recent origins. Therefore, it is not possible to have a true natural preserve, but wildlife has claimed the created land and the area presents its own interesting story of habitat creation and adaptation which is worthy of preservation. The 2002 “Wetlands Center Master Plan” planning study called for the creation of an educational outreach facility, research facilities, and a resource center. This planning study – especially the elements which provide for site-based research and educational outreach – should continue to be followed. Elevated trails and the Wetlands Pavilion have already been established. Additionally, a 2002 technical memorandum produced for the Texas General Land Office, entitled “Pelican Island Shore Protection Alternatives” made recommendations for armoring portions of the Pelican Island shoreline; those recommendations should be implemented and incorporated into future projects in this area.

A portion of the area designated as the Shore Area Reserve has been recently used for depositing dredge spoils. Spoils activity should either be minimized and eventually curtailed or should be actively incorporated as a learning opportunity. While it would be disingenuous to deny spoils deposition here on the grounds that it is destructive, given that most of the land of Pelican Island is made of spoils, ongoing use of the land for spoils may create difficulties in fulfilling the opportunities which the reserve presents.

As the research TAMUG conducts increases, new opportunities for public-private partnerships and incubator-type technology development will also increase. The master plan identifies a seven-acre parcel as a potential location for facilities housing operations of this type, called the Technology Development Center. The parcel is adjacent to the spoils site, so that land may also be incorporated into the area in the future.

The area available here is rather limited, so land-intensive uses are not the best choice for the site. Entities which need large amounts of land should be encouraged to locate nearby rather than on the campus itself. While TAMUG currently has a significant amount of unused land, future growth of the campus will require almost all of that land. The potential benefits of co-locating private facilities on the campus should be weighed against the future needs of the university.



Shore near bridge

Other Areas



Campus open areas

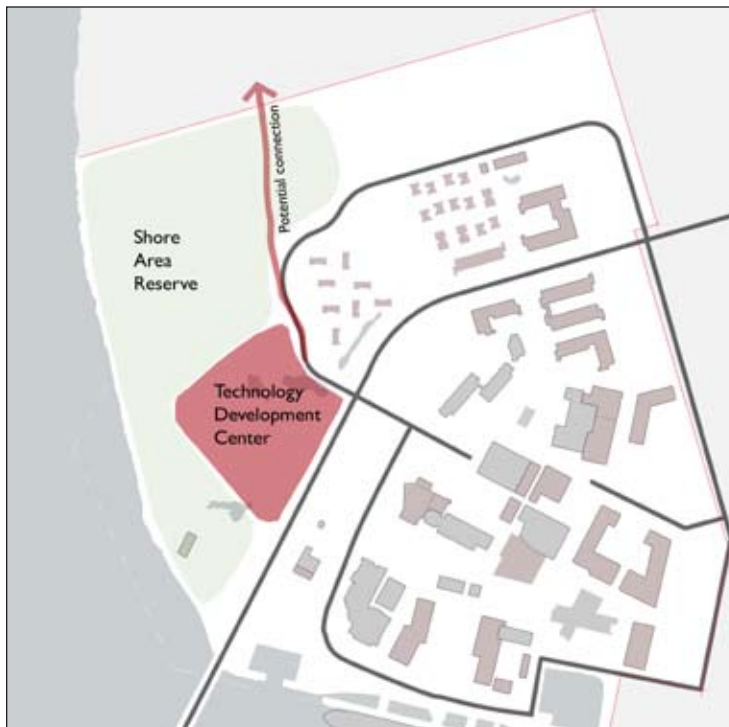

Shore Area Reserve

Shore Area Reserve

- Reserve a significant amount of land across Seawolf Parkway to remain undeveloped
- Implement the recommendations in the “Pelican Island Shore Protection Alternatives” technical memorandum
- Consider reducing or eliminating spoils dumping, especially as university grows
- Continue following the 2002 “Wetlands Center Master Plan” with modifications as shown in this master plan
- Connect the reserve to the rest of campus with a trail system

Technology Development Center

- Reserve approximately seven acres for technology incubator and research public-private partnerships
- Locate land-intensive uses off-campus because of the limited area available
- Allow for a future connection to Port of Houston land north of the campus

Open Spaces

- Preserve open space by increasing the density of the campus core
- In addition to the Shore Area Reserve, maintain views and access to shore areas



Recreational field locations

North Physical Plant and Utility Corridors

TAMUG's utility infrastructure is in dire need of reconstruction. Many components, including perhaps the majority of the buried piping, are at or beyond the end of their useful lives. The construction of the Science Building has eliminated all redundancy from the system; it is, quite literally, at full capacity. Failure of a single chiller or rupture of a pipe during the cooling season may cause cooling outages which could last for significant periods of time.

Aside from issues of capacity and age, the current infrastructure also limits where new construction can occur. Several otherwise ideal sites are crossed by utility lines. While these lines can – and must – be moved in order to continue developing the campus, it is important to avoid creating the same site constraints with the new utility lines. To this end, several alignments have been designated as utility corridors. Future utility line routings should be constrained to these corridors, which can be connected to form a looped system. It is vitally important that new utility lines installed in the loop be sized for the full future development of the campus. As TAMUG's growth targets evolve, line sizes should change accordingly.

The existing physical plant occupies prime territory next to the waterfront. Infrastructure around the plant is insufficient for future campus needs, and in many cases it is near the end of its useful life. For these reasons, the master plan calls for construction of a new physical plant near J.F. Fields Road, east of the Physical Education Building. Storage and maintenance functions which are located in the existing physical plant yard will be relocated to the new physical plant. The existing chillers, boilers, and cooling towers will remain, but other portions of the building will be demolished to make way for new academic and research facilities. The existing plant will operate as a satellite plant controlled remotely from the new physical plant.

- Address aging and fully loaded infrastructure immediately
- Establish utility corridors in new work to make future connections simpler
- Implement a looped system to allow for growth and to minimize the need to replace existing lines beyond what is necessary for maintenance
- Size utility lines for future construction, not current needs
- Build a new main physical plant and reduce the current plant to a satellite operation
- Move personnel and maintenance functions out of the current physical plant to make room for a new building site
- Include space for campus police, including personnel, storage, reception, and other support spaces. Dedicated parking spaces for police vehicles should be included in the yard.
- Route main telecom ductbanks in the same corridors as thermal utilities and water in order to avoid conflicts with future building sites
- Study the condition of existing lines and perform preventive repairs and replacements as necessary; thermal lines and telecommunications conduits in particular have deteriorated significantly



Parking lots and capacities

Roadways and Parking

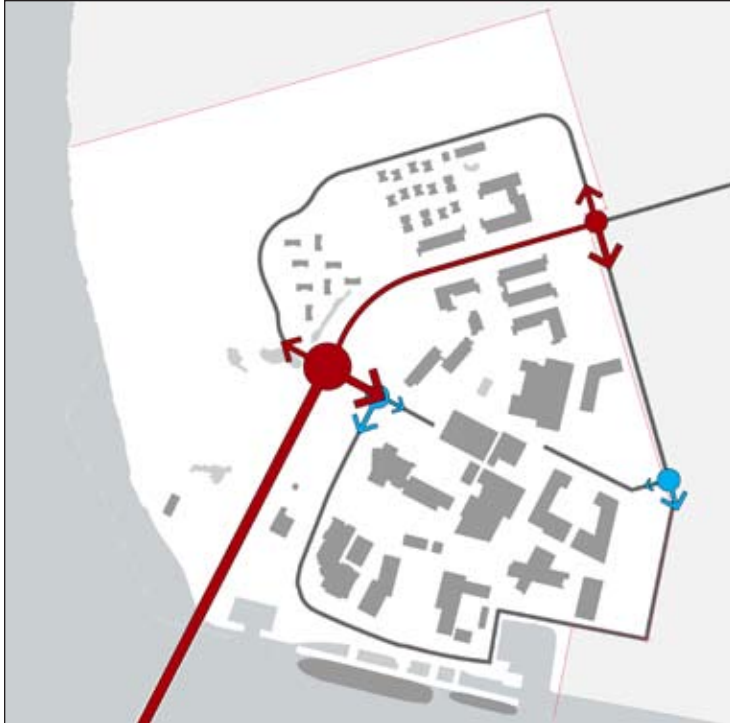

Campus vehicular entrances



Parking lot locations and campus roadways

With a few exceptions, TAMUG's current vehicular circulation system is already generally successful at keeping vehicles to the perimeter of the campus. The master plan reconfigures roadways in order to resolve existing conflicts and to open up several sites for development. Overall parking as shown on the master plan is sufficient for the university as it grows to 3,000 students.

- Locate roadways at the perimeter of campus to minimize vehicular/pedestrian conflicts and to clear building sites
- Space parking lots out so that every building has nearby parking
- Maintain and enhance the main campus entrance
- Maintain roads which loop past the waterfront to preserve service access for large vehicles
- Place large lots near student housing because of demand
- Ensure that emergency vehicles have access to all buildings



2014 plan

Major projects 2009 to 2014

Construction of Corps platform in Ship's Green (1)

Construction of new boat basin (15), construction of boat basin storage/offices (2), reconstruction of dock (3), and implementation of shoreline mitigation program (16)

Construction of library expansion (4)

First expansion of student center (5)

Academic/Research: Construction of Academic/Research I (6)

Housing: Demolition of Mariner Hall and construction of Residence Hall 3 (7), Residence Hall 4 (8), and student apartments (9)

Recreational facilities: Construction of one multi-purpose field, one soft-ball field, tennis courts, two basketball courts, and trails (10)

Roads: Reconstruction of campus entrance (11) and partial north loop road (12); construct median in Seawolf Parkway (13)

Utility Infrastructure: Construction of North Physical Plant (14) and demolition of office portion of existing physical plant; renovation of core utility lines and initial construction of utility loop

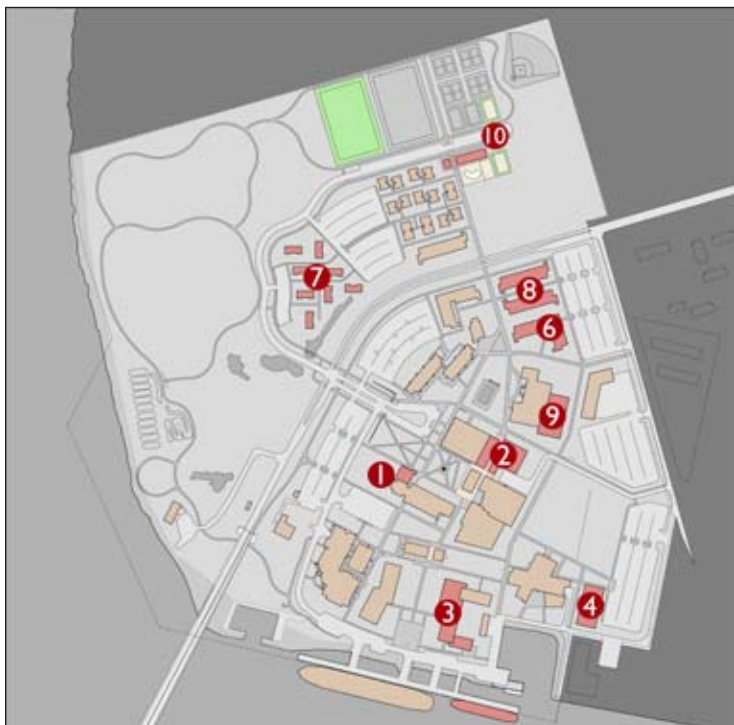

2020 plan

Major projects 2014 to 2021

Admin/Student Services: Construction of administration addition (1) and second expansion of student center (2); demolition of Sea Aggie Center

Academic/Research: Construction of Academic/Research 2 (3) and Academic/Research 3 (4)

Housing: Construction of Residence Hall I (Corps housing) (6), married student housing (7), and Residence Hall 2 (8)

Recreational facilities: First expansion of PE Building (9); construction of basketball courts and construction of student activity center (10)

Utility Infrastructure: Expansion of utility loop and addition of capacity to North Physical Plant as required



2028 master plan

Major projects 2021 to 2028

Construction of auditorium (1)

Academic/Research: Construction of Academic/Research 4 (2) and Academic/Research 5 (3)

Housing: Construction of Residence Hall 5 (4)

Recreational facilities: Second expansion of PE Building (5)

Roads: Completion of north loop road (6)

Utility Infrastructure: Expansion of utility loop and addition of capacity to North Physical Plant as required; expansion of sewage treatment plant (7)

While the master plan has a nominal 20-year time frame, implementation can occur in advance of or behind that schedule. Phasing plans are presented here in two main stages, plus the existing plan and the final master plan. These plans together represent an assumed progression of construction. As TAMUG more closely determines needs for various types of space and as funding is available, construction of actual facilities will likely proceed at a different pace and in a different order, but this in no way negates the master plan so long as the basic concepts are followed.

- Academic facilities will be built at a steady pace throughout the master plan period
- Because of land constraints, housing must be built across Seawolf Parkway to replace the beds in Mariner Hall. Development of roads, parking, and recreational fields in the same area should occur at that time
- A library expansion should be built soon because of the existing need for library space
- Construction of the North Physical Plant and initial phases of the utility loop should occur as soon as possible because of current needs and the condition of the existing infrastructure

All costs given in 2008 dollars

Academic Projects	Cost per SF	GSF	Project Cost
Academic/Research 1	\$400	70,000	\$28,000,000
Academic/Research 2	\$400	110,000	\$44,000,000
Academic/Research 3	\$400	60,000	\$24,000,000
Academic/Research 4	\$400	80,000	\$32,000,000
Academic/Research 5	\$400	90,000	\$36,000,000
Library Expansion	\$350	35,000	\$12,250,000
Student Center Addition 1	\$350	8,000	\$2,800,000
Student Center Addition 2	\$400	16,000	\$6,400,000
PE Building Addition 1	\$325	21,000	\$6,825,000
PE Building Addition 2	\$350	10,000	\$3,500,000
Auditorium	\$450	16,000	\$7,200,000
Administration Addition	\$300	9,000	\$2,700,000
Housing Projects	Cost per bed	Beds	Project Cost
Residence Hall 1	\$70,000	230	\$16,100,000
Residence Hall 2	\$70,000	220	\$15,400,000
Residence Hall 3	\$70,000	150	\$10,500,000
Residence Hall 4	\$70,000	150	\$10,500,000
Residence Hall 5	\$70,000	250	\$17,500,000
Student Apartments	\$50,000	210	\$10,500,000
Married Student Housing	\$50,000	80	\$1,600,000
Infrastructure Projects	Cost per SF	GSF	Project Cost
North Physical Plant	\$800	19,000	\$15,200,000
Initial Utility Loop Construction	-	-	\$15,000,000
North Loop Road Construction	-	-	\$4,000,000
Sewage Treatment Plant Expansion	-	-	\$6,000,000

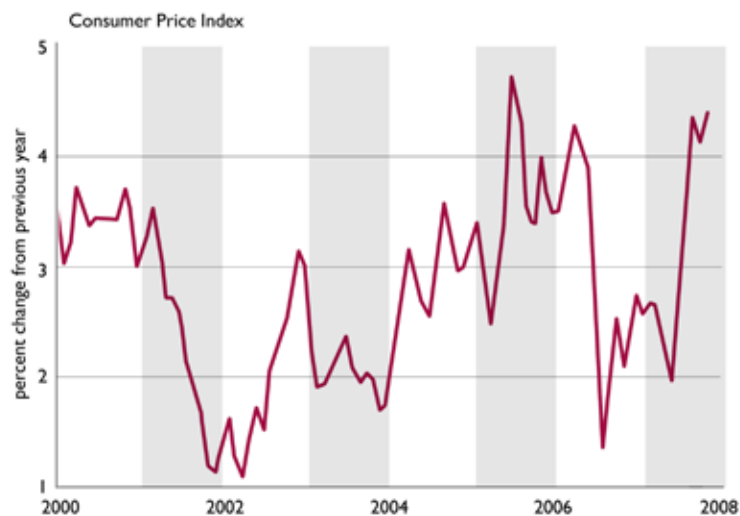
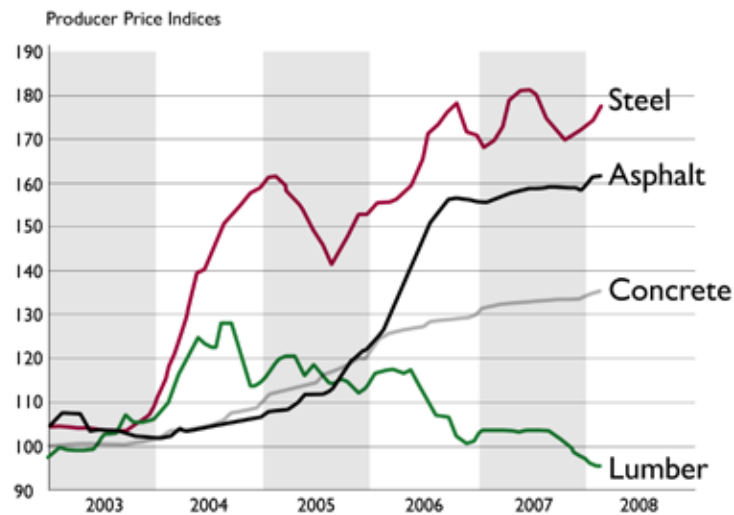

These project cost estimates, which include construction cost, design fees, FF&E, and other project costs, are based on recent data from similar projects and are escalated to the year 2009. Additional escalation should be added to each figure to properly account for inflation and other increases in project costs when specific a specific timeline for each project is determined. While the price of construction has been rising rapidly in the past several years, recent economic events will likely have a deflationary impact on prices going forward. An industry expert should be consulted prior to assigning cost estimates for budgetary purposes.

- Costs of many construction materials have risen considerably over the past five years, but commodity prices have fallen recently
- Material cost escalation trends have outpaced inflation over the past five to ten years
- Recent declines in the state-wide amount of construction should create a more positive bidding climate in the near-term
- Energy prices have been volatile; the price of energy affects the cost of construction disproportionately
- In spite of present trends, many other forces affect the cost of construction, so a cost estimator should be consulted prior to budgeting a project

Introduction	B.1
Colors and Materials	B.3
Building Shapes and Forms	B.5
Glazing and Shading	B.7
Walkways and Plazas	B.9
General Hardscape	B.11
Landscape	B.13
Signage and Identification	B.21
Harbor and Roads	B.23
Exterior Lighting	B.25
Environmental Considerations	B.27
Disaster Readiness	B.31

Design Guidelines



Useful architectural guidelines are not a proscriptive list of requirements and limitations. Rather, guidelines are the result of an analysis of existing practices intersected by recommendations for strengthening and clarifying the elements already present on campus. While portions of these guidelines do set out fairly strict codes for certain aspects of campus development, most of the guidelines should be viewed as principles which can be incorporated into projects in many different ways.

As TAMUG grows toward the goals outlined in this master plan, the pressures of available land, limited funds, and increasing needs will influence the design and construction of new facilities. Expedient solutions to these demands and the scattered aesthetic responses of many different designers must not be allowed to dominate new development as they have on many college campuses. Selection of architects should be made in part on the basis of prospective designers' understanding of these master plan concepts.

It is the responsibility of each designer who works on the TAMUG campus to build upon the strengths of the campus and to contribute toward the overall planning goals of the university. These design guidelines provide an aesthetic and functional structure for future projects, and adherence to these guidelines will produce a unified, cohesive campus.



Steel structure



Masonry and steel

Blues, blue-greens, greens, grays, and whites are all colors which are found in marine environments and maritime construction. Colors from that palette should be emphasized over the more land-oriented browns and earth tones which currently dominate campus. However, new buildings should include some colors which correspond to existing campus colors; new construction should not be entirely divorced from the existing campus. Salmon should also be used as an accent color.

Existing campus buildings are a mix of concrete, concrete block, and brick. There is not a singular pervasive material used, but there are similarities in the colors and textures of materials. Elements from this basic sandy and brown concrete and brick palette should be used in future buildings, but they should be only a means to reinforce new buildings' connection to the existing campus rather than as dominant elements themselves.

New materials should be representative of TAMUG's involvement in technologically-oriented fields. Glass, metals, and composite materials are more visually consistent with TAMUG's programs and mission.



Hull-like forms and materials

Colors and Materials



Steel, rope, and blues



Samples of campus materials

- Blues, greens, grays, and whites should be the predominant colors used in new buildings
- Include small amounts of browns and earth colors which relate to the existing campus
- Salmon should be used as an accent color
- Glass, metals (including cable), and composite materials such as corrugated cement board should play a leading role in new buildings
- Use some materials which relate to the existing campus in new buildings, but in a supporting role



Science Building,



Bridge and sails

Building form should, where possible, refer to shapes which relate to maritime and marine settings as well as those which reflect TAMUG's advanced technological programs. References need not be literal; in fact, abstractions may be more useful in conveying the feel of the various referents without historical confusion. Copying



Texas Clipper III



Paddle wheel housing

the architectural language of a Galveston wharfside building verbatim, for example, would not be faithful to the history or setting of that building, but an abstracted version of the language implies that building as a precedent without creating a hollow imitation.

Existing campus buildings are mostly one or two stories. As the campus increases in density, new buildings should be two to three stories, like the Science Building. Taller buildings can and should be used to create a sense of enclosure in open spaces like the Ship's Green.

Building Shapes and Forms

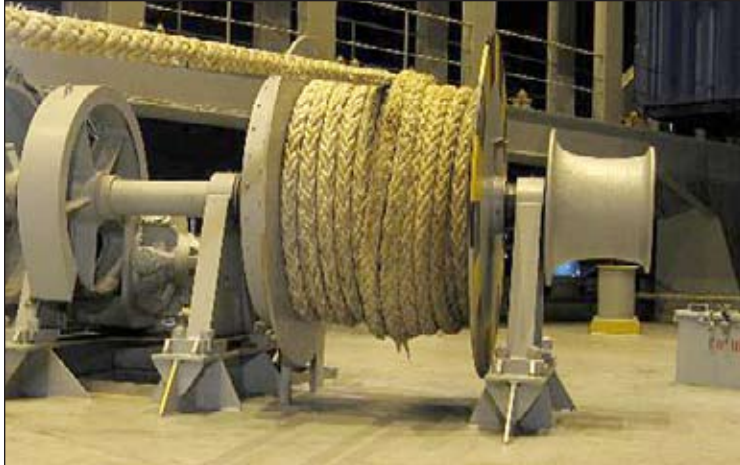

Winches



Winches and fairleads



Sail-like forms

The forms and appearance of buildings should be carefully considered and unified, though not uniform. Most of TAMUG's existing buildings do not bear any relationship to the character of the school, and they should be a relatively minor influence in the appearances of new buildings.

- Use abstractions of various historical, technological, and maritime forms
- Incorporate elements from existing campus buildings
- Buildings should be two to three or more stories, particularly if they form edges of campus open spaces
- Building-mounted equipment such as exhaust stacks should be visually prominent, rather than hidden



Historic swinging shutters



Kirkham Hall entrance



Arcade at the Engineering Building

Galveston has a relatively inhospitable climate in which to incorporate large amounts of glass. The summer temperatures and threat of damage from hurricanes are both obstacles to having significant areas of glazing. However, coastal communities around the world have developed strategies to cope with these situations. Using those techniques will reinforce the maritime character of the university.

There are excellent examples in Galveston of several types of shutters. Swinging shutters which can be closed over the windows are used on many buildings, both old and new, and there are also a number of buildings with shutters which roll

Glazing and Shading



Rolling shutter

sideways across windows. Both types of shutters are acceptable for new buildings. Glazing should be sized and proportioned accordingly. Fake shutters should never be used.

Several buildings on campus have metal or concrete horizontal sunshades; shades like these should be used on new buildings. Steel shades, in particular, are visually appropriate for the high-tech, maritime-inspired character which all new buildings should have. Window glass should be clear, untinted, low-e, double-paned glass.

- Use large amounts of glazing, but protect it from the sun and hurricane damage
- Shutters (including both swinging and side-rolling) protect against wind-driven objects
- Louvers and exterior sunshades protect against direct insolation while allowing light through
- Use clear, untinted, low-e glass
- Reflective glass must not be used



Pavers



Tree pattern at the central pedestrian spine



Primary walkways



Secondary walkways

Walkways and Plazas



Tree pattern at the central pedestrian spine

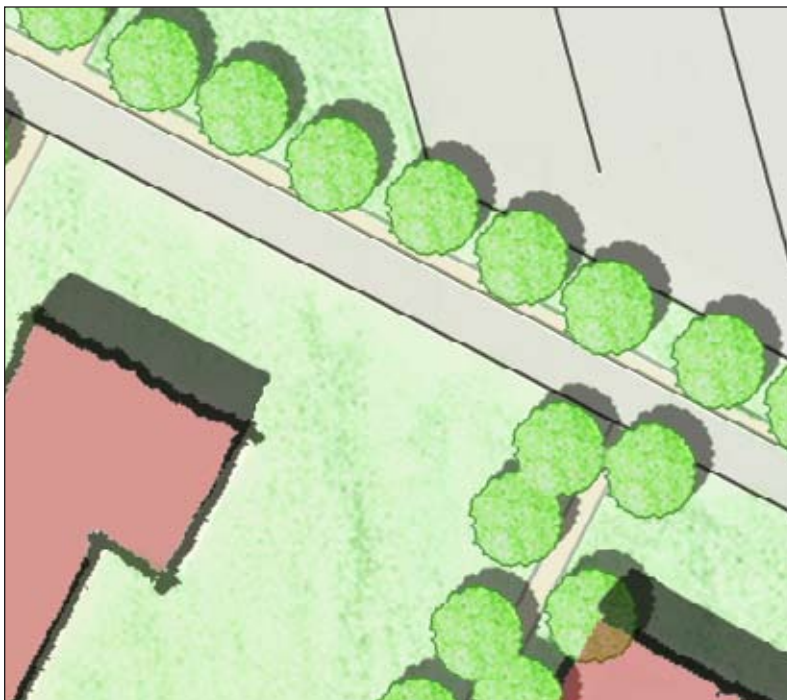

Trees at secondary walkways

- Primary walkways should be given more visual importance and development than secondary walkways
- Primary walkways should be emphasized with double rows of trees, benches and litter receptacles, and special paving at plazas
- The central pedestrian spine should have alternating palm trees and shade trees on both sides: a repeating pattern of one palm tree, then two shade trees
- Secondary walkways should have a single row of trees spaced appropriately to give shade and should have benches and litter receptacles at intersections with other paths
- Plazas and other gathering places should be paved with medium- to dark-colored tumbled cobblestone-type pavers rather than concrete
- Match new sidewalks to existing sidewalk materials



Steel bench

Exterior furniture and other furnishings are important components of a university's appearance. They should be located in plazas and along paths where they can be best used. The university should standardize on one family of furnishings from a major manufacturer so that all current and future projects can use the same pieces. Deteriorated and aging furniture should be progressively replaced with the same selections. Teak is a highly appropriate and durable material for seating elements, and coated steel is also a good choice for Galveston's environment. All furniture should be simple in form and unobtrusive in color.



Litter receptacle

General Hardscape



Chain bollards



Teak bench

- Standardize site furniture and use high-quality metal or teak
- Locate furniture along paths and in open spaces as well as in a mix of shaded and sunny spots
- Place trash containers throughout campus, including in parking lots
- Use bollards and similar structures at water's edge both for functional and aesthetic reasons

The landscape character of the campus should support the overall maritime character of the campus through the use of plants that are compatible with a coastal marine environment. Functionally, it should provide a unifying landscape framework for the many individualized spaces and design elements that exist and are planned for the campus while strengthening the relationship between the built and native environments. The landscape should also reflect a campus goal of creating a pedestrian friendly atmosphere.

The campus is located in a sub-tropical climate zone that is characterized by hot summers, short, mild winters, occasional heavy rains and dry spells, high humidity, and proximity to salt air and water from the gulf. Within certain limitations, conditions on campus should be favorable to a lush planting environment. One of the biggest limiting factors is that Pelican Island was built primarily with dredged fill material which is very sandy and has a high salt content. Existing ornamental plantings on campus exhibit a wide range of adaptation to the local conditions. Some are thriving while others appear to be struggling for survival. It is important to learn from which plants are successful and to apply that knowledge to future plantings.

In general, landscaping should be utilized on the TAMUG campus in a manner that achieves several important objectives including:

- Defining campus open spaces
- Defining circulation systems
- Creating design interest
- Providing protection from the elements
- Screening of undesirable views

There are specific zones identified in this campus master plan that provide opportunities to use specific landscape treatments that reinforce the distinct use and character of those zones.

Seawolf Parkway

Although TAMUG owns land on both sides of Seawolf Parkway, it is not clearly evident. The west side of the road is largely undeveloped. The large existing live oak trees near the current main entrance are very effective at establishing a campus presence, but only for the east side. It is recommended that double rows of live oak trees continue to be planted along both sides of Seawolf Parkway to unify and reinforce an overall campus presence and to create a distinct sense of arrival.

Campus Entrance

The rows of existing live oak trees at the main entrance are the most prominent landscaping feature on campus and make a great first impression to people arriving on campus. Additional plantings at this location should have high visual interest and provide clues to this entrance being the primary entrance to the campus. Ornamental plantings and seasonal color should be used in conjunction with entry monument signs. The main



Live oaks along Seawolf Parkway

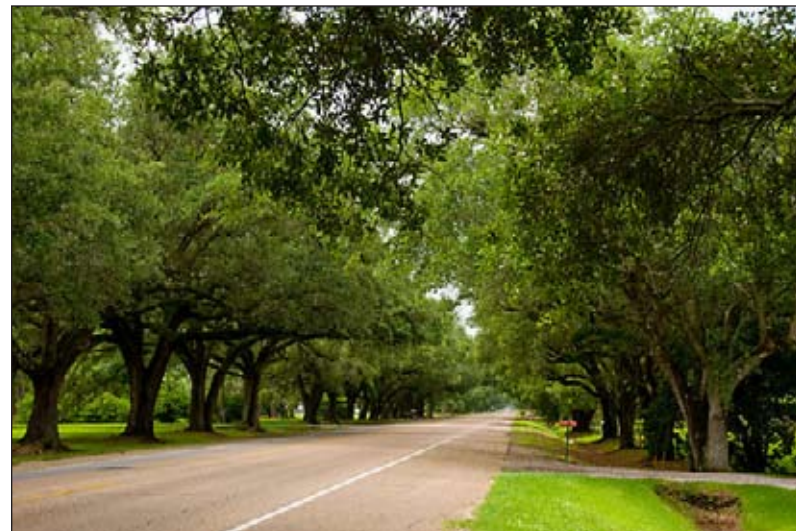

Canopy of live oaks lining road

entry drive to the visitor drop-off and parking should be lined with palm trees. Their tall vertical form will be easy to identify within the surrounding landscape as a significant location on campus.

Courtyards

Courtyard and ceremonial spaces function as formal and informal outdoor rooms for events, campus rituals, social encounters and unstructured recreation and relaxation. The central courtyard is the symbolic heart of the campus, and landscaping for this area should reflect that significance. The geometric space should be lined with double rows of canopy trees to define the space and to provide shade for the walkways around the space. Landscaping at the Ship's Green should reinforce a visual and physical connection to the waterfront and the Texas Clipper. The existing rows of trees

in the middle of the space are in poor condition and should be replaced with live oak trees that will provide a formal evergreen connection that enhances the Corps drill platform.

Campus Loop Road

To reinforce the internal vehicular circulation around campus, it is recommended that a single row of palm trees be planted along one side of the campus loop road. The palm trees will provide a visual reference, distinct from pedestrian circulation, for the vehicular access around campus.



Palms lining street

Parking Lots

Planting islands for trees should be provided in all parking lots to break up the expanse of paving and create shaded areas. Planting islands with trees should be provided at the ends of all parking rows and along the interior of the parking lots. At a minimum, the area of the parking islands should be equal to the size of two parking stalls for the healthy growth of a canopy tree.

Parking lots that are adjacent to streets or in view by the public should have a landscape buffer. The buffer should be bermed and/or landscaped in order to partially screen cars from view.

Walkways

Pedestrian comfort and protection from weather is an important element of a successful campus design. Large shade trees should be planted along major pedestrian paths to protect pedestrians from the summer sun as well as to provide a visual reference for pedestrian circulation through campus.

The character of the landscape should reinforce the maritime character of the campus, and plants which are compatible with a coastal marine environment should be used.

Other objectives for landscape include:

- Defining campus open spaces
- Defining circulation spaces
- Creating design interest
- Providing protection from the elements
- Screening undesirable views

- Double rows of live oaks should line Seawolf Parkway on both sides of the road to establish a campus presence

- The existing live oaks at the main entrance should be augmented with ornamental plantings and seasonal color

- The main entry drive and the campus loop road should be lined with palm trees in order to create a unified visual reference for those drives

- Trees should be planted in parking lots in minimum two-space plots

- Walkways should be lined with large shade trees in order to provide protection from weather

Open Space/Nature Preserve

The land west of Seawolf Parkway is mostly undeveloped but has evolved over time as a haven for native wildlife and plants and should continue to be preserved as such. The ecological and educational work of the TAMUG Wetland Center should be enhanced and expanded. The lagoon on the east side of the Pelican Island bridge should be incorporated into the overall Wetland Center with trails and interpretive graphics. The trail under the bridge should be enhanced to provide better access to the trails on the east side of campus. Efforts should be taken to eliminate any invasive and/or non-indigenous plants from overtaking this natural environment.

Security

The composition of landscaping should adhere to the principles of design for defensible space: clear visibility should be maintained at the ground plane, sight lines into the space from adjacent buildings and areas should be maintained, and traffic patterns should avoid dead or isolated zones.

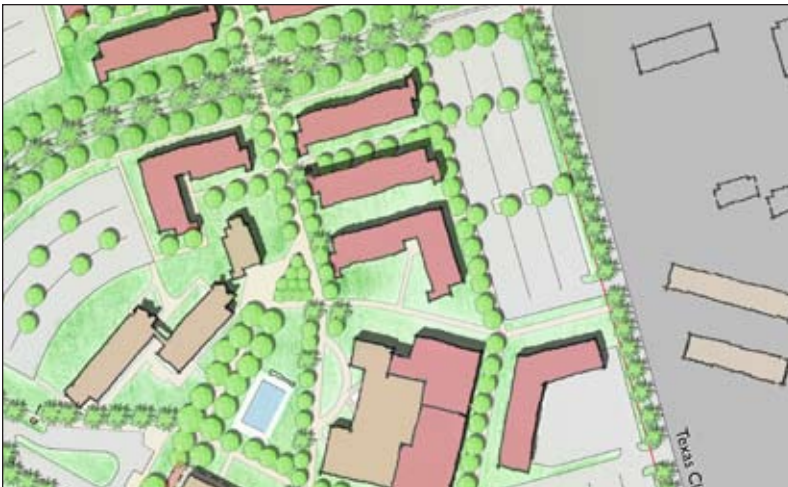

Example of tree plantings in parking lots and along walkways

Irrigation

An important goal for the campus should be the reduction of water usage for landscaping which can be accomplished by using a combination of drought tolerant plants and a high-efficiency irrigation system. All new planting beds should be drip-irrigated to target water to the plants and to reduce waste due to over watering, evaporation, and runoff. Spray irrigation for lawn areas should be restricted to high profile areas and high activity areas. It is recommended that a computer-programmed central controller station be installed to monitor and adjust all irrigation on campus. The irrigation system shall irrigate each area per the plant material selection according to a water-zoning concept; i.e., plant zones requiring the least amount of water should be irrigated less frequently than others.

Soil Amendments and Preparation

Poor sandy and salty soils due to the island being created from dredge fill have had a negative effect on many plantings on campus. While some have thrived, others appear stressed and are under performing. Any future plantings will need to address the soil conditions in which they are planted. Over time, salt will be slowly leached from the soil. Until that process is completed, it is recommended to use imported topsoil, prepared planting mix, and/or compost to build up a viable growing medium for general planting. Prior to adding any amendments or fertilizer, it should be determined whether there is a problem with the soil that is related to poor nutrition or poor physical properties of the soil. Laboratory soil tests should be performed on existing campus soils to determine the proper amendments needed for the soil to best benefit the plantings.

Planting

To assist in creating design interest on the campus, plant material shall be carefully selected in order to provide interesting color, form, texture and fragrance to all campus spaces.

Trees are critical to the quality of life on a campus for students and faculty. Large trees offer shade to pedestrians during warm weather. Trees of a single variety should be used to reinforce specific zones or features, such as a single variety of palm tree for the campus loop road. Otherwise, it is recommended to use a variety of tree species to provide visual interest and to prevent a monoculture of trees that are more susceptible to pests and disease.

Shrubs and smaller trees are more appropriate choices for prominent locations, courtyards, small spaces, or corridors, as well as around buildings, to create a graceful transition from the vertical planes of the building to the horizontal plane of the site. Overly intricate plantings which are out of character and scale with the setting should be avoided. The preferred approach to shrub planting is to employ masses of low-maintenance plants to direct pedestrian traffic, provide visual interest, and screen unsightly views. Simplicity of plant character in keeping with the architectural palette will create a unified composition properly scaled to the size and style of the buildings and spaces.

Lawns are an important component to the campus landscape. They literally create the ground plane between buildings. Good drainage should be provided to prevent standing water and breeding of mosquitoes.

Annual flower and perennial plantings are an important part of the landscape materials palette and can contribute greatly to the campus appearance. Because of high maintenance requirements, seasonal planting should be limited to few but larger areas to maximize visual impact. The most appropriate areas for seasonal plantings would include campus entries and visitor destinations.

Landscape

All plant materials specified for future construction projects on the TAMUG campus shall be of the highest quality available. All trees, shrubs, and ground-cover plants shall be container-grown. Large trees shall be a minimum of four inches in caliper and shall be grown in a minimum of one-hundred gallon containers. Understory trees shall be a minimum of three inches in caliper and shall be grown in a minimum of sixty-five gallon containers. Shrubs shall be grown in a minimum of five-gallon containers, and groundcover and vines shall be grown in a minimum of one-gallon containers. Lawn areas shall be solid sod in high activity areas and hydromulch in areas of lower activity. Lawn type shall be either St. Augustine or Common Bermuda. Select shade trees for the following characteristics: high clear trunk, broad spreading canopy, and tolerance to salt and poor sandy soil conditions.

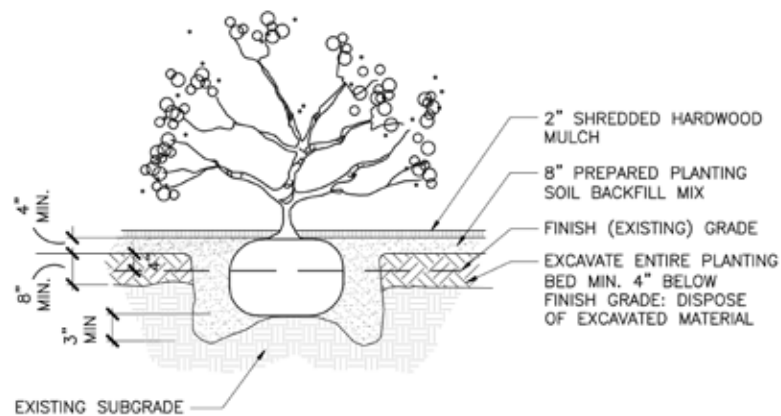

Raised shrub planting bed

- The open space/nature preserve west of Seawolf Parkway should be preserved, and invasive and non-indigenous plants should be removed
- Visibility should be maintained at the ground plane for security
- Drought-tolerant plants and high-efficiency irrigation should be used in order to reduce water demands
- Because of the poor soil quality, imported topsoil, prepared planting mix, and/or compost should be used at any future plantings
- Laboratory tests should be performed on campus soil in order to determine proper amendments
- Lawns should be well drained in order to prevent standing water
- Specified plant materials should be high-quality: four-inch trees should be grown in 100-gallon containers; shrubs should be grown in five-gallon containers, and groundcover and vines should be grown in one-gallon containers
- Lawns (either St. Augustine or Common Bermuda) should be solid sod in high-activity areas; hydromulch is acceptable in areas of lower activity

Recommended Plants

Large Canopy Trees

Eucalyptus camaldulensis “Galveston”	Galveston Eucalyptus
Firmiana simplex	Chinese Parasol Tree
Juniperus virginiana	Eastern Red Cedar
Magnolia grandiflora	Southern Magnolia
Magnolia virginiana	Sweetbay Magnolia
Pinus elliottii	Slash Pine
Pinus taeda	Loblolly Pine
Pinus thunbergiana	Japanese Black Pine
Quercus shumardii	Red Oak
Quercus virginiana	Live Oak
Salix babylonica	Weeping Willow
Taxodium distichum	Bald Cypress
Ulmus crassifolia	Cedar Elm
Ulmus parvifolia	Lacebark Elm

Small/Medium Trees

Bauhinia purpurea	Orchid Tree
Callistemon citrinus	Bottlebrush
Callistemon viminalis	Weeping Bottlebrush
Cercis canadensis	Redbud
Eriobotrya japonica	Loquat
Feijoa sellowiana	Pineapple Guava
Ilex vomitoria	Yaupon Holly
Ilex attenuata “Savannah”	Savannah Holly
Koelreuteria bipinnata	Golden Rain Tree
Lagerstroemia indica	Crapemyrtle
Myrica pumila	Wax Myrtle
Parkinsonia aculeate	Palo Verde
Punica granatum	Pomegranate
Vitex agnus-castus	Chaste Tree

Palms

Butia capitata	Pindo Palm, Jelly Palm
Chamaerops humilis	Mediterranean Fan Palm
Cycas revoluta	King Sago Palm
Dioon edule	Virgin Palm
Livisona chinensis	Chinese Fan
Phoenix canariensis	Date Palm
Phoenix dactylifera	Medjool Palm
Phoenix roebelenii	Pygmy Date Palm
Phoenix sylvestris	Sylvester Date Palm
Raphis excelsa	Lady Palm
Sabal mexicana	Mexican Fan Palm
Sabal minor	Dwarf Palmetto
Sabal palmetto	Palmetto
Serenoa repens	Saw Palmetto
Syagrus romanzoffiana	Queen Palm
Trachycarpus fortunei	Windmill Palm
Washingtonia robusta	Washington Fan Palm

Large Shrubs

Agave americana	Century Plant
Alpinia zerumbet	Variegated Shell Ginger
Aralia papyrifera	Rice Paper Plant
Bambusa, spp.	Bamboo (Clumping Only)
Caesalpinia gilliesii	Bird of Paradise
Caesalpinia pulcherrima	Pride of Barbados
Elaeagnus pungens	Elaeagnus
Hibiscus coccineus	Texas Star Hibiscus
Juniperus chinensis	Hollywood Twisted Juniper
Ligustrum japonicum	Waxleaf Ligustrum
Leucophyllum, spp.	Texas Sage
Malpighia glabra	Barbados Cherry
Musa ornata	Dwarf Banana
Myrica cerifera	Wax Myrtle
Nerium oleander	Oleander
Photinia fraseri	Red-Tip Photinia
Pittosporum tobira	Pittosporum
Platyclusus arborvitae	Aborvitae

Landscape



Orchid tree



Medjool date palm



Lacebark elm



Golden raintree

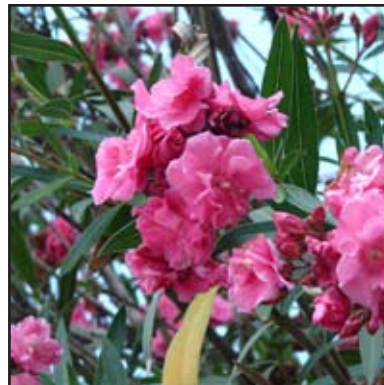

Oleander



Bird of paradise



Hibiscus



Bird of paradise



Sago palm

Recommended Plants

Small/Medium Shrubs

Abelia grandiflora
Asparagus densiflorus “Myserii”
Canna indica spp.
Carissa macrocarpa “Fancy”
Cycas revoluta
Cyperus alternifolius
Dietes iridioides
Hibiscus moscheutos
Hibiscus rosa sinensis “Cherie”
Fatsia japonica
Ilex vomitoria “Nana”
Juniperus chinensis
Lantana camara
Lantana montevedinsis
Loropetalum chinense “Nana”
Malpighia puniceifolia
Malvaviscus arboreus
Nandina domestica
Nerium oleander “Petite Salmon”
Ophiopogon japonicus “Nana”
Opuntia ficus-indica
Philodendron selloum
Plumbago auriculata
Raphiolepis indica
Ruellia equisetiformis
Xanthosoma sagittifolium

Abelia
Foxtail Asparagus Fern
Cannas
Fancy Natal Plum
Sago Palm
Umbrella Plant
Butterfly Iris
Rose Mallow
Cherie Chinese Hibiscus
Fatsia
Dwarf Yaupon Holly
Juniper
Lantana
Trailing Lantana
Dwarf Loropetalum
Dwarf Barbados Cherry
Turk’s Cap
Nandina
Petite Salmon Oleander
Dwarf Mondo Grass
Spineless Prickly Pear
Cut-Leaf Philodendron
Plumbago
Indian Hawthorne
Ruellia
Elephant Ears

Ground Cover

Liriope gigantea
Liriope spicata
Ophiopogon japonicus
Trachelospermum asiaticum

Giant Liriope
Lily Turf
Mondo Grass
Asian Jasmine

Vines

Antigonon leptopus
Bignonia capreolata
Bougainvillea spp.
Ficus pumila
Gelsemium sempervirens
Hedera helix
Passiflora, spp.
Pseudogynoxys chenopodioides
Syngonium podophyllum
Tecoma capensis
Trachelospermum jasminoides
Thunbergia grandiflora

Coral Vine
Cross Vine
Bougainvillea
Creeping Fig
Carolina Jasmine
English Ivy
Passion Flower
Mex. Flame Vine
Arrowhead Vine
Cape Honeysuckle
Confederate Star Jasmine
Thunbergia

Grasses

Andropogon gerardii
Cortaderia selloana
Miscanthus sinensis “Adagio”
Muhlenbergia capillaris
Spartina spartinae
Uniola paniculata

Big Blue Stem
Pampas Grass
Adagio Miscanthus
Gulf Muhly
Gulf Cord Grass
Sea Oats

Landscape



Umbrella plant



Trumpet vine



Dwarf Barbados cherry



Giant liriope



Ruellia



Fatsia



Elephant ear



Canna



Natal plum

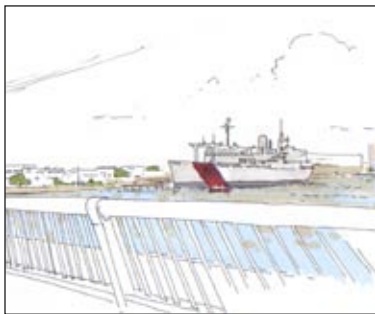

Signage and Identification



As the Texas A&M Galveston campus continues to grow, it will become even more important to implement a comprehensive family of signage and environmental graphic components that include vehicular directionals that guide motorists to campus entrances, parking areas, and special events. Clearly identifying parking areas with signs that display the lot designation as well as its intended use for staff, visitors, and students is vital as well— especially as the resident student population increases. Cross-referencing these parking area designations with parking information available on the university's web site and printed information on parking permits (both long-term and day permits) will ensure that students, faculty, and visitors are properly oriented to parking.

Signage directing motorists to, around, and through the campus should carry no more than a few consistently-presented destinations. These signs will direct primarily to campus entrances and parking areas, since most motorists will park and walk to their destination. Vehicular signs should also be scaled appropriately to the roadway they serve and to the speed of traffic. These signs can also be conspicuous components of the campus infrastructure, conveying a desired aesthetic. At certain key locations, directional signage might accommodate temporary messages to direct visitors to special event parking in more tidy fashion than ad-hoc temporary signage and postings. Operational and regulatory signs on campus, such as speed limit notices, restricted parking, and fishing information should be standardized and mounted to a campus-standard pole to convey a sense of order and continuity. A well-articulated, functional, flexible, and tasteful site signage system will allow motorists to more easily navigate the campus, yielding a more efficient experience for the visitor and a safer environment for everyone.



Texas Clipper III

The utilitarian nature of working waterfronts means that they tend to accumulate various trailers, containers, and other equipment clutter more readily than other campus locations. This presents a dilemma: such equipment is required for the operations of the harbor and docks, but if care is not taken to organize and maintain the waterfront, then the activity around and connections to the waterfront which are such a critical part of this master plan will suffer. There are numerous working harbors which are also tourist centers, however, so this issue can be and has been overcome by planning, coordination, and attention to ongoing maintenance.

Standards for the cleanliness, organization, and care of the waterfront should be enforced by the university just as cities enforce appearance-related ordinances. Responsibility for maintaining these standards should be given to a single person who reports directly to a vice president.

The campus should be a primarily pedestrian place. The placement of loading docks and service drives should be carefully considered to reduce their impact on the pedestrian character of the campus. Similarly, vehicular drop-offs internal to campus should be implemented only where necessary, and even then, should be designed to minimize intersections with pedestrian walks. Drop-offs should be located at the ends of pedestrian walks at the perimeter of campus.

As befits a pedestrian-centric campus, roadways on campus should be sized to provide only the necessary space for vehicles to circulate, not to encourage traffic

flow. Travel lanes should be no more than 11 feet wide. Where low to moderate levels of traffic are expected, lanes may be as narrow as ten feet wide. Vehicular access to the boat harbor and the Texas Clipper's dock should be more generous than roadways elsewhere on campus because of the service requirements of the vessels and waterfront activities.

Pedestrian crossings should be prominently marked and designed to make drivers aware that they are crossing a pedestrian thoroughfare. Raised intersections and distinctive surfacing, as illustrated, may be used at heavily-used crossings. Care should be taken to avoid obstructing bicycle traffic, however, and all crossings must comply with the Texas Accessibility Standards.

Site furniture should be standardized on several types. As existing furniture deteriorates, it should be replaced with a designated style, and new construction should specify this style as well. High quality painted metal or teak furniture should be selected; these types will minimize maintenance and will be more comfortable than concrete furniture. Furniture should be located along major pedestrian paths – site furniture is most useful near the heaviest pedestrian traffic. Shade should be provided at most, but not all, seating locations; there should be a variety of conditions at seating including heavy shade, part sun, and full sun. Trash containers should be placed throughout the campus, including near and in parking lots.

Paving materials for new pedestrian walkways should match paving at existing walks, which are primarily smooth-surface concrete. Consideration should be given to using medium- or dark-colored pavers at plazas and other open spaces to give them a more human scale and to reduce the glare caused by large areas of concrete paving.



Utility yard

Harbor and Roads

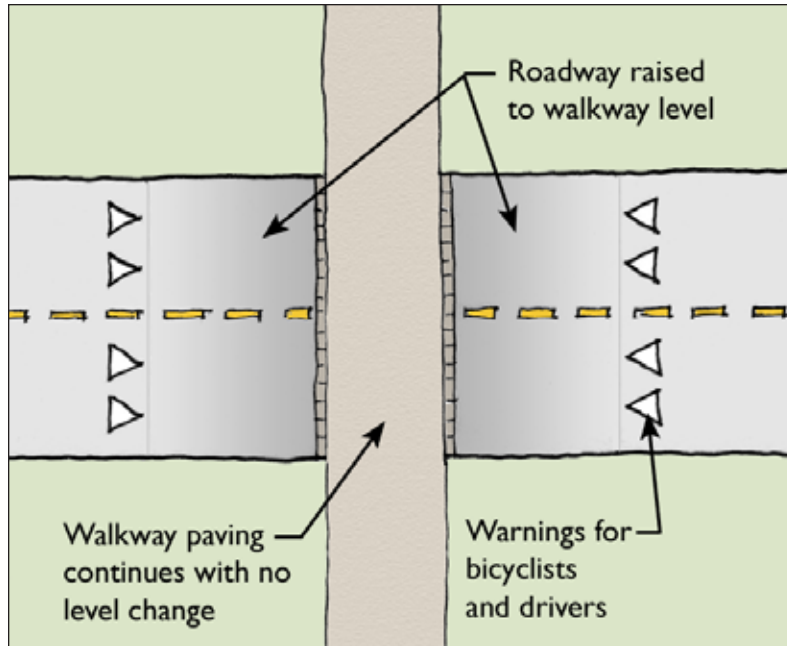

Pedestrian road crossing



Entrance boulevard and median at Seawolf Parkway

Boat Harbor and Waterfront

- Establish and enforce standards for waterfront appearance
- Build facilities as necessary for storage, maintenance, etc. rather than using piece-meal solutions

Vehicular Circulation

- Reserve the center portions of campus for pedestrians
- Locate service elements away from pedestrian places and screen them
- Size roadways to provide modest traffic lanes except where access requirements create the need for larger lanes
- Clearly mark pedestrian crossings and use contrasting paving and raised intersections where appropriate
- Use medians only at major entrance boulevards; otherwise, minimize road widths
- Preserve access to campus buildings for emergency vehicles



Pedestrian site lighting

Exterior Lighting

Lighting is an important part of the campus environment both for reasons of safety and of appearance. Good lighting will create a welcoming atmosphere, which is an important part of generating nighttime campus life. Handcrafted sconces and other building-mounted fixtures are more appropriately scaled for pedestrians than tall light poles are and should be used where possible. Lighting should be enhanced in areas which are relatively heavily used at night, and well-lit connections should extend from these areas to housing and food service facilities.

Lamps should be selected for color-rendering performance and for efficiency. Those which render colors poorly, such as sodium vapor lamps, should not be used despite their higher theoretical efficiency. In many cases, the superior color rendering performance of lamp types like metal halide allows the installation of less wattage to achieve the same visual performance, so efficiency should be understood in this context. Lamps should have a color rendering index value of 78 or above. This includes incandescent, metal halide, and daylight and warm fluorescent lamps. Mercury vapor, low and high pressure sodium, and cool fluorescent lamps should not be used for general outdoor lighting, though mercury and cool fluorescent are acceptable for illuminating plant materials. Lamp types should be standardized as much as possible to provide even lighting and to minimize the costs associated with maintaining many different types of lamps. Lamp replacement should be done on a schedule, rather than on an as-needed basis, to ensure that replacements are all of the same type.

Pole-mounted lighting fixtures should be standardized both for new projects and for replacement of existing fixtures. Taller light standards with unobtrusive fixtures can be used to provide overall low fill light levels in large spaces, but pedestrian walks and plazas should be lit by fixtures on standards of twelve feet or less. Poles along walkways and in plazas should be spaced to achieve light levels which range from one to five footcandles. Light levels should at no point vary more than 4:1 within a 100 square foot area. Lamps should be 70 to 120 watts, depending upon conditions. Wall-mounted sconces cannot provide large amounts of general-purpose light, but by highlighting architectural elements, sconces can help to define spaces. Exposed lamps are not allowed, and glare should be eliminated.

Good lighting heightens the interest of spaces at night, but it also makes people feel safe. Encouraging this feeling of safety is not simply a matter of increasing the amount of light in a space, which is the most common solution to a perceived lighting problem. In fact, high nighttime light levels often create glare and shadows which contribute to a feeling of insecurity. Safe lighting consists of applying low, but very even levels of light to areas like parking lots and walkways, and slightly higher levels of light to plazas and areas immediately outside buildings. Higher light levels can and should be cast on building exteriors, as this provides the impression of brightness and enhances perceptions of safety without negatively affecting night-adapted vision.

- Metal halide, mercury vapor, LED, and warm fluorescent lamps should be used for outdoor lighting
- Sconces, building-mounted fixtures, and low pole fixtures are appropriately scaled for pedestrian environments
- Low, even night lighting enhances security more than bright pools of light
- Standardize pole and fixture types and replace lamps on a regular schedule (according to lamp type) rather than on an as-needed basis
- Light selected building exteriors to define spaces at night

Awareness of environmental topics and interest in energy and resource conservation have become significant issues in building construction. The role of TAMUG as a leader in studying and working in the environment should be translated into the way that the university designs and constructs buildings.

While many opportunities are available only at the level of building design, and not at the master planning level, there are also many situations which can be addressed on a site-wide basis. The LEED system of certification provides a framework for establishing environmentally sound projects. Choosing to pursue certification on major new building projects is typically a system-level decision, but TAMUG should go through the LEED process when feasible. Even if certification is not pursued, the LEED framework can still be a guide, and designers should be held to it as a means of evaluating design choices.

The credits in the “Sustainable Sites” section of the LEED Resource Guide are a good starting point for site-wide issues. However, blindly following the LEED criteria is not sufficient. A thoughtful designer can and should adapt design responses to particular sites and programs in order to achieve more than can be encompassed in a points-based system. The following addresses several pertinent LEED credits in the “Sustainable Sites” section with TAMUG-specific commentary.

Energy and Atmosphere Credit 1

The state of Texas mandates that all new buildings meet the requirements of ASHRAE 90.1. This mandate requires that all new building use at least 14% less energy than a base building as described in ASHRAE 90.1 Appendix G. Additional percentage points can be obtained with the use of high efficiency glass and more energy efficient wall systems.

Credit 1: Site Selection

Because most, if not all, of TAMUG’s land falls under the criteria of land which should not be developed, this credit cannot be achieved except in limited circumstances. However, the requirements of this credit should be viewed as ideal and pursued where possible. The master plan calls for fairly dense development, which mitigates the damage done by site expansion.

Credit 3.2: Water Use Reduction of 30%

With the use of low flow urinals and toilets a 30% reduction in potable water usage can be obtained.

Credit 4: Alternative Transportation

As TAMUG’s population grows, alternative means of transportation will become more important. Public transportation connections should be sought in order to provide connections to Galveston and the mainland. While bicycle traffic across the current Pelican Island bridge is unsafe and should be discouraged, residents of Pelican Island dormitories and apartments should be encouraged to bike to and around the campus. Additionally, the feasibility of using alternative fuel for campus vehicles should be investigated.

Parking capacity for the future campus has been sized based on current usage. As more students live on or close to campus, their need for personal vehicles may be diminished. TAMUG should encourage on-campus students to do without personal vehicles and off-campus students to carpool whenever possible. Preferred parking spaces for carpooling students should be established. If such programs are successful in reducing parking demand, fewer parking spaces than called for in the master plan should be built.

Credit 5: Site Development

Site disturbances should be limited as much as is feasible. The area designated as the shore area reserve should be untouched by development. While most of Pelican Island is the product of dumping dredge spoils and is therefore not natural in the purest sense, it is still worthwhile to protect undeveloped areas.

Credit 6: Stormwater Design

Limiting runoff is not as significant a concern on TAMUG’s campus as at other institutions because of the campus’s proximity to the sea. However, the quality of the runoff is every bit as important as at inland sites, if not more so. Impervious cover should be minimized, and techniques such as eliminating contaminants and performing water polishing via on-site vegetative filtration should be pursued.

Credit 6.1 Controllability of Systems, Lighting

Use of occupancy sensors and or the building automation system will allow this point to be obtained and will result in a reduction in energy usage.

Credit 8: Light Pollution Reduction

Minimizing light pollution will primarily benefit the school by reducing energy costs. Exterior lighting systems should be carefully designed to place light only where it is needed and only in the amounts which are required.

Condensate Collection

Galveston is a very humid climate, and all outside air used for HVAC is pretreated. This pretreatment removes the moisture. This condensate should be collected and utilized for irrigation or other non-potable water uses.



US night lighting

Environmental Considerations

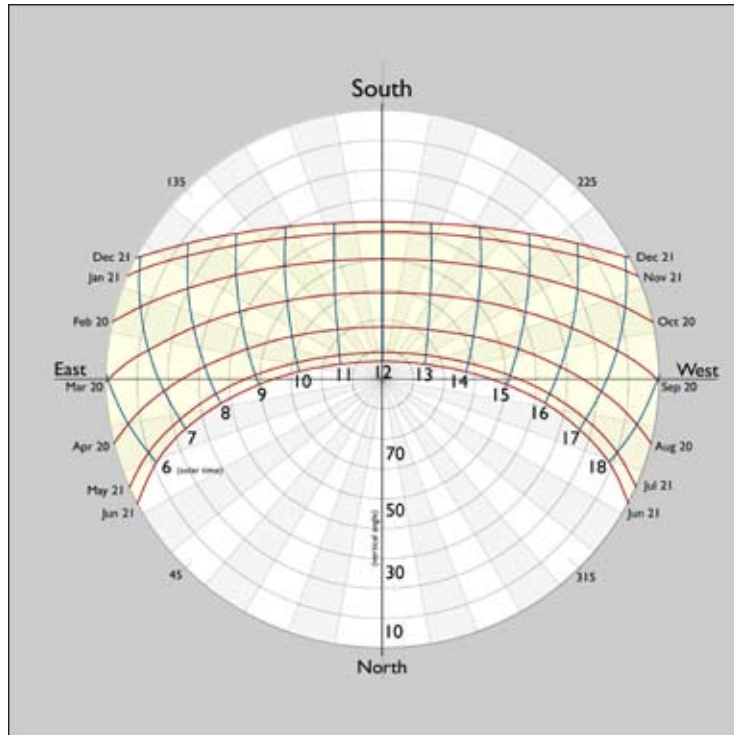

Sun angle diagram for Galveston

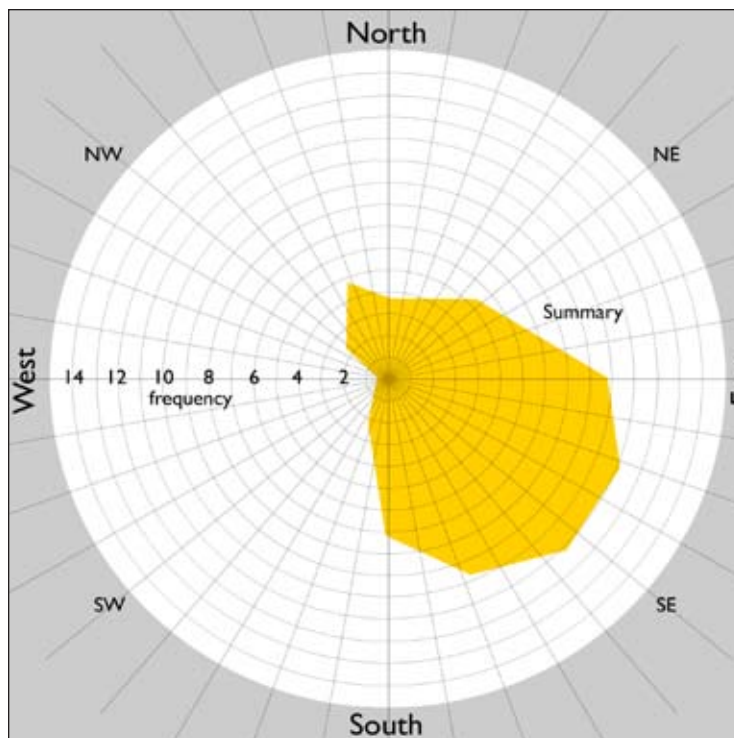

Summary of yearly wind direction and velocity

- Pursue LEED certification if possible
- If LEED certification is not feasible, use the LEED rating system as a guide
- Focus on elements which have the greatest benefit in Galveston's climate
- Orient buildings and spaces to take advantage of prevailing winds
- Orient buildings to protect against sun
- Connect campus walkways to a future walkway over the bridge from Galveston Island

In addition to specific LEED credits, there are also many other techniques and products which should be explored by designers of future projects. Some of those which are most applicable to TAMUG are listed below.

Shading Structures

Windows should be shaded wherever possible. Shading is the most effective way to reduce solar gain through windows, and it is also in keeping with the design guidelines which encourage steel and aluminum window shading. Shades can either be applied individually to windows or they can be large structures or extensions of roofs which shade a larger area of glass. Designers should investigate both horizontal and vertical shades, as they can both be effective depending on exposure. Wind uplift is a consideration – shades should be designed to resist hurricane-force winds.

Building Orientation

The footprints of buildings are somewhat determined by the master plan, but the massing and fenestration of those buildings are resolved by individual designers. The way that building masses are disposed and how windows are placed on those masses can have a considerable effect on building performance. Designers should investigate ways to locate the largest amounts of glass on north and shaded south faces.

Prevailing wind directions should also influence how buildings and outdoor spaces are oriented. Summer winds tend to come from the south and southeast, so those exposures should be open. Northwest exposures should also be open to allow for the free flow of those breezes from the south through spaces. Winter winds come from the north and northeast, so those exposures should be relatively closed to minimize cold winds.

Rainwater Collection

Given Galveston's annual rainfall, there is a significant opportunity to collect rainwater for use in landscape irrigation. This issue can be pursued in individual buildings projects as well as in a campus-wide system. The designers of each project should research the viability, cost, and benefits of implementing rainwater collection, storage, and distribution for irrigation. One way to begin this process without overburdening any particular project with system-wide costs would be to require individual projects to collect enough water to supply most of the needs of the landscaping installed in that project. The lessons learned in those projects should dictate whether it is to TAMUG's benefit to implement campus-wide systems.

Low-VOC, Recycled, and Locally-sourced Materials

Building projects should use materials which have a low environmental impact whenever possible. Materials which do not emit chemicals as they cure and age contribute to healthier conditions inside buildings. Products which are made from recycled material encourage future recycling and in many cases require less energy to produce. Materials which are manufactured locally do not require expensive and pollution-causing transportation and are more cost-effective in many cases.



Rainwater collection cisterns

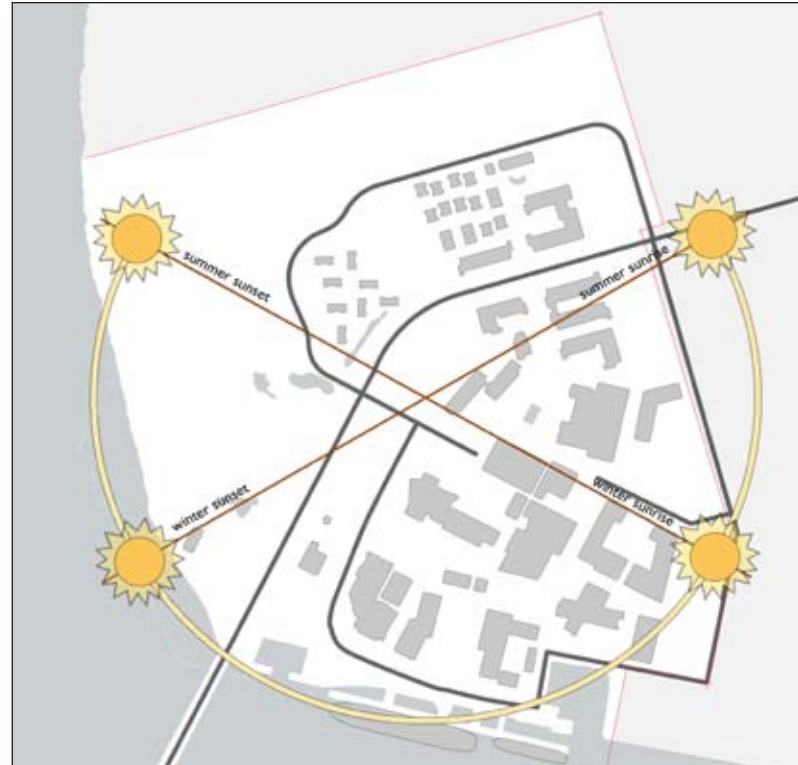

Sun angle diagram for Galveston

Environmental Considerations

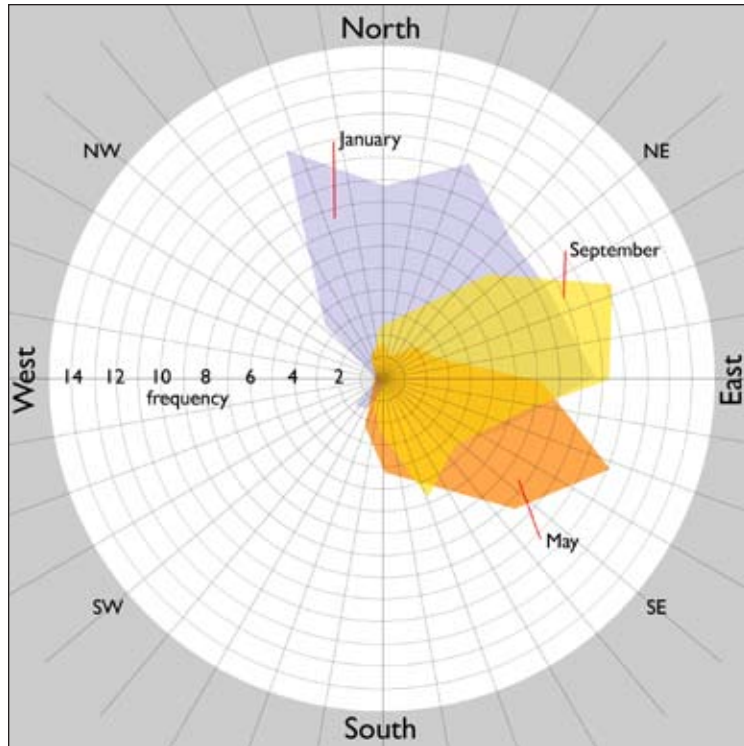

January, May, and September wind speed and direction

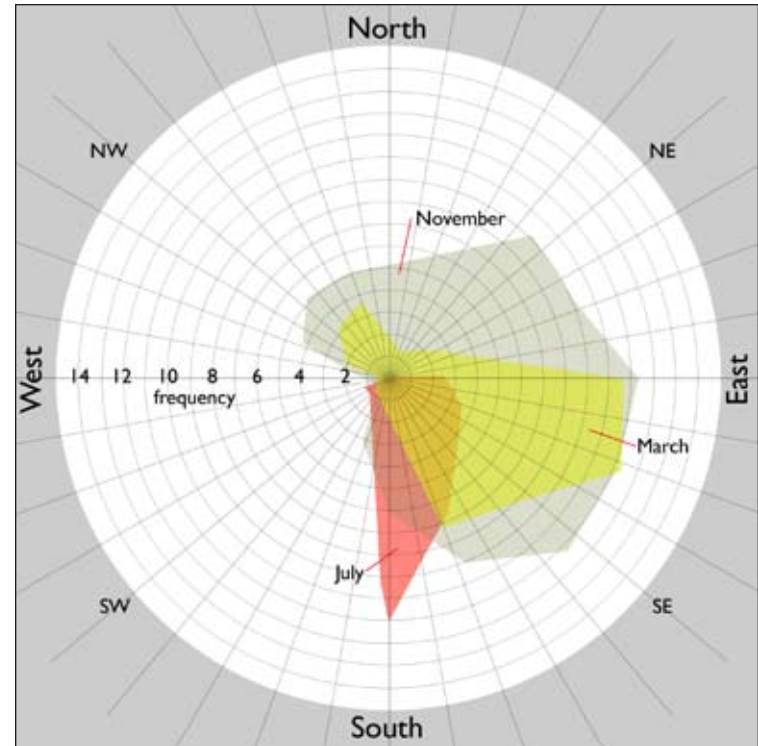

March, November, and July wind speed and direction

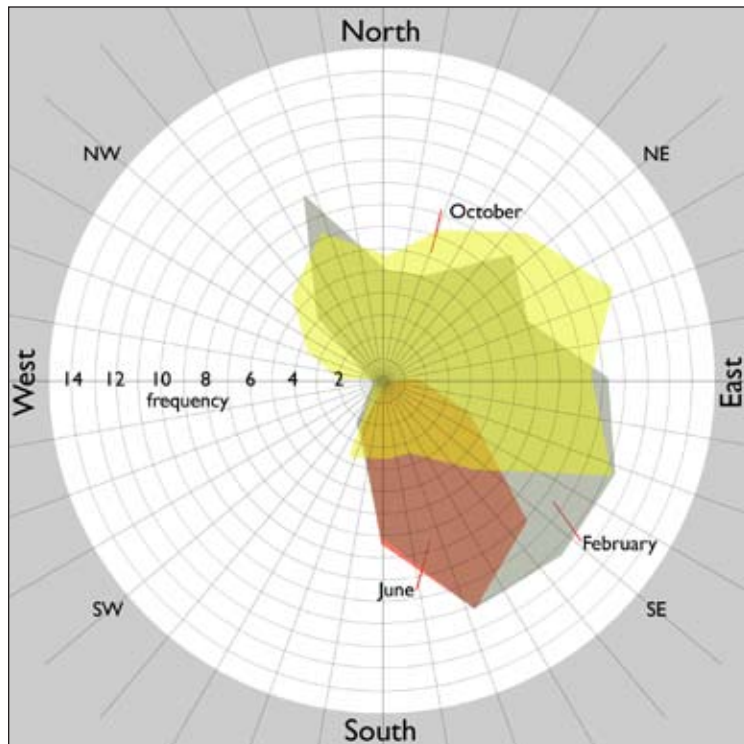

February, June, and October wind speed and direction

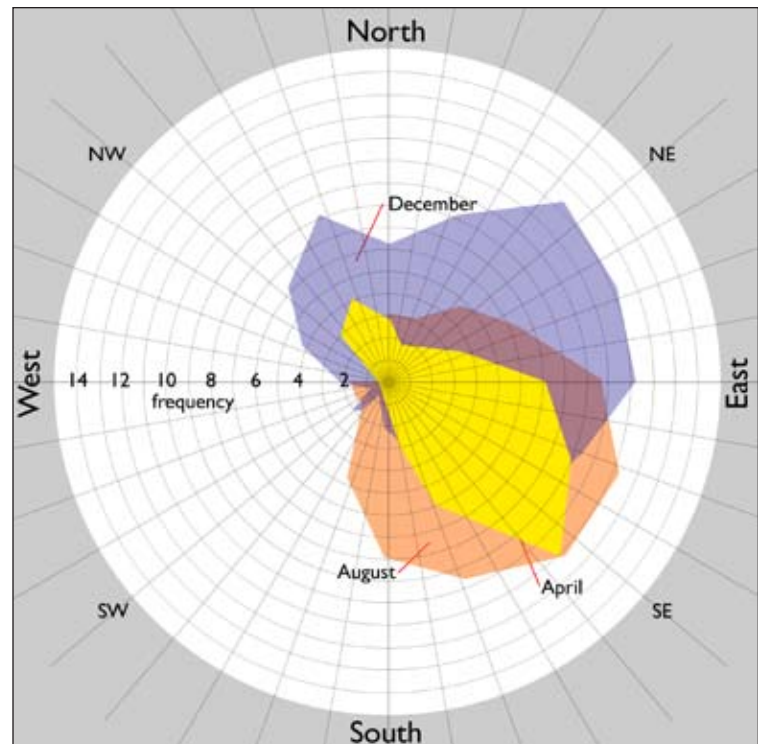

April, August, and December wind speed and direction

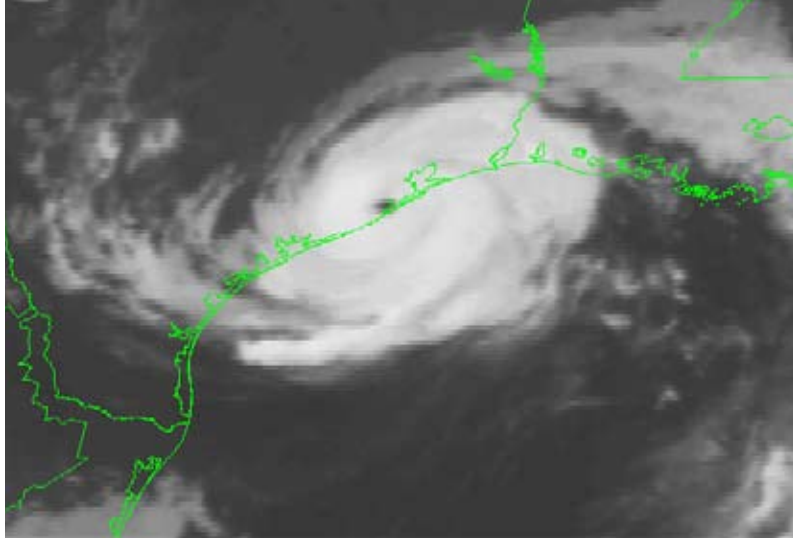

Hurricane Alicia at landfall

The two primary hazards to facilities in a hurricane are wind and water. Proper planning and construction can avert some potentially problematic situations.

Wind Issues

Current building codes have requirements regarding construction practices in areas of high winds. These codes should be regarded as minimum acceptable practices, and facilities should be examined on a case-by-case basis to decide whether more stringent standards should be applied. Aggregate-topped roofs should not be allowed on new buildings, and older buildings with these roofs should be retrofitted as soon as it is feasible.

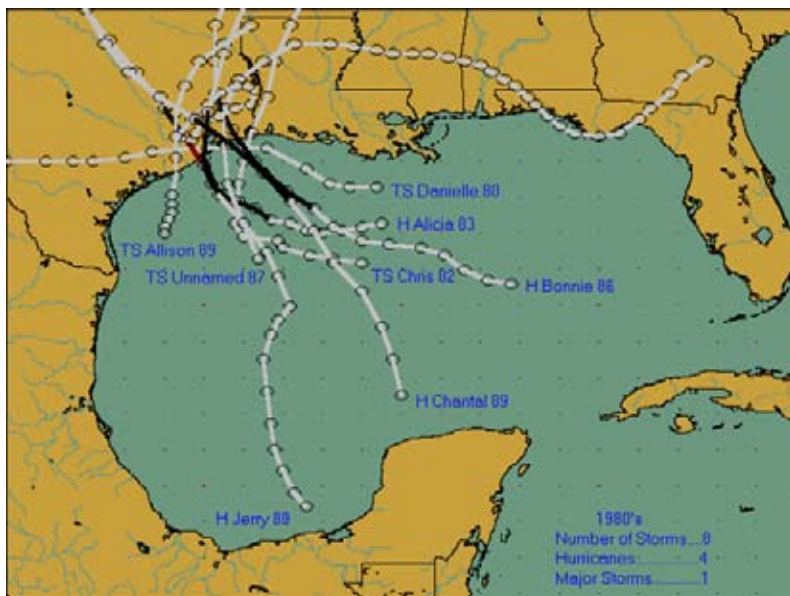

*Hurricanes which struck the upper Texas coast in the 1980s
Image from NOAA/National Weather Service*

Flooding

There are two basic methods to protect equipment or areas from flooding; all techniques fall into one of these two categories. The first is a passive system – for example, placing critical equipment above flood level or using unbroken hydrostatically-designed walls. These solutions require no human intervention, nor do they rely on the proper operation of equipment. The second set of solutions, including various types of flood doors and flood barriers, are active systems. They must be operated in order to protect against flooding. These systems may be entirely automated, but they still depend on moving doors, seals, or some other type of mechanism.

It may also be useful to distinguish solutions by potential failure types (in all of these cases, “failure” is taken to mean the loss of capability of the system to protect the equipment in question from floodwater). An active system may fail by improper or untimely operation, mechanical failure, poor design, or a number of other potentials. The set of passive solutions which use “bathtub” type passive protection basins may fail by breach of containment, whether that be by structural collapse, by penetration of the water-tight vessel, or by operational failure strictly related to the protection method itself (as in the case of fire sprinklers flooding undrainable bathtub protection at a Houston facility). A passive system which relies on placing equipment above flood level may fail only by structural collapse. Some of these failure modes, like structural failure, are simple and can be guarded against relatively easily. Others, like operational failure, can involve complexities which are not evident at first glance.

Flood protection in new construction should be passive in all cases, and where possible, it should be a passive type which does not rely on containment. Active solutions may be required in retrofitting existing buildings, but the use of those solutions should be minimized and passive solutions used wherever feasible.

Most facilities at the Mitchell Campus are near 15 feet above sea level, and this affords a significant level of protection from storm surges. However, the possibility of storm surges in the range of 15 to 20 feet above sea level exists. Because of this, utility and research equipment should be located above 20 feet MSL.

Planning

Most of the issues relate to disaster preparation are not issues which can be addressed in a master plan – a complete handbook of coordinated operational policies is the best way to ensure that the university is properly prepared for a disaster. Such a handbook should include policies regarding spare equipment, situational protection of buildings from a looming event, and other preparations.

The Texas Clipper is a particular benefit in disasters – it is a mobile power source which is built to withstand devastating conditions. As after Hurricane Ike, the ship can be used as housing for selected personnel. Reconstruction

Disaster Readiness



Finished floor elevations and topography

of the pier may allow the ship to be left there during some hurricane events, rather than moved to another location, which would allow it to more quickly and efficiently be adapted as housing and potentially as a power generator in the event of an emergency. Cost and other feasibility issues likely preclude building permanent connections to enable the ship to serve as a power source in the event of power failure, but the possibility of such connections should be considered in any reconstruction of the pier and waterfront area.

- Classify buildings according to priority for maintaining and restoring utility services
- Identify facilities and operations with special infrastructure needs and provide for them appropriately
- Where possible, cluster spaces which require emergency generator and/or climate control backup so that equipment can be located centrally
- Build facilities with floor elevations at or above 17 feet MSL; where this is not possible, locate critical operations on upper floors
- Locate mechanical, electrical, and valuable laboratory equipment above 20 feet MSL wherever possible, and maintain spares for equipment which is below that elevation
- Investigate possibilities for a backup communications feed to/from the mainland
- Pursue the possibility of converting the wastewater plant to a lift station in order to avoid flooding problems with that facility

Introduction	C.1
Wayfinding and Signage	C.3
Electrical Systems	C.33
Thermal Energy	C.35
Water, Sewer, and Storm Water	C.37
Telecommunications	C.41

Technical Report

Utility infrastructure should be a target for investment in the same way that buildings are – while it may be easier to fund academic projects, neglecting utilities can and will handicap the university’s ability to grow efficiently and to serve the needs of the campus. Given the current state of the infrastructure at the campus, it is a requirement, not an option, to upgrade systems in order to provide for future building projects.

The following pages describe upgrades necessary to the thermal energy, telecommunications, and other systems in order to allow the master plan to be achieved. Phasing of the site utilities should follow the site phasing plans found at the end of the first section of this document.

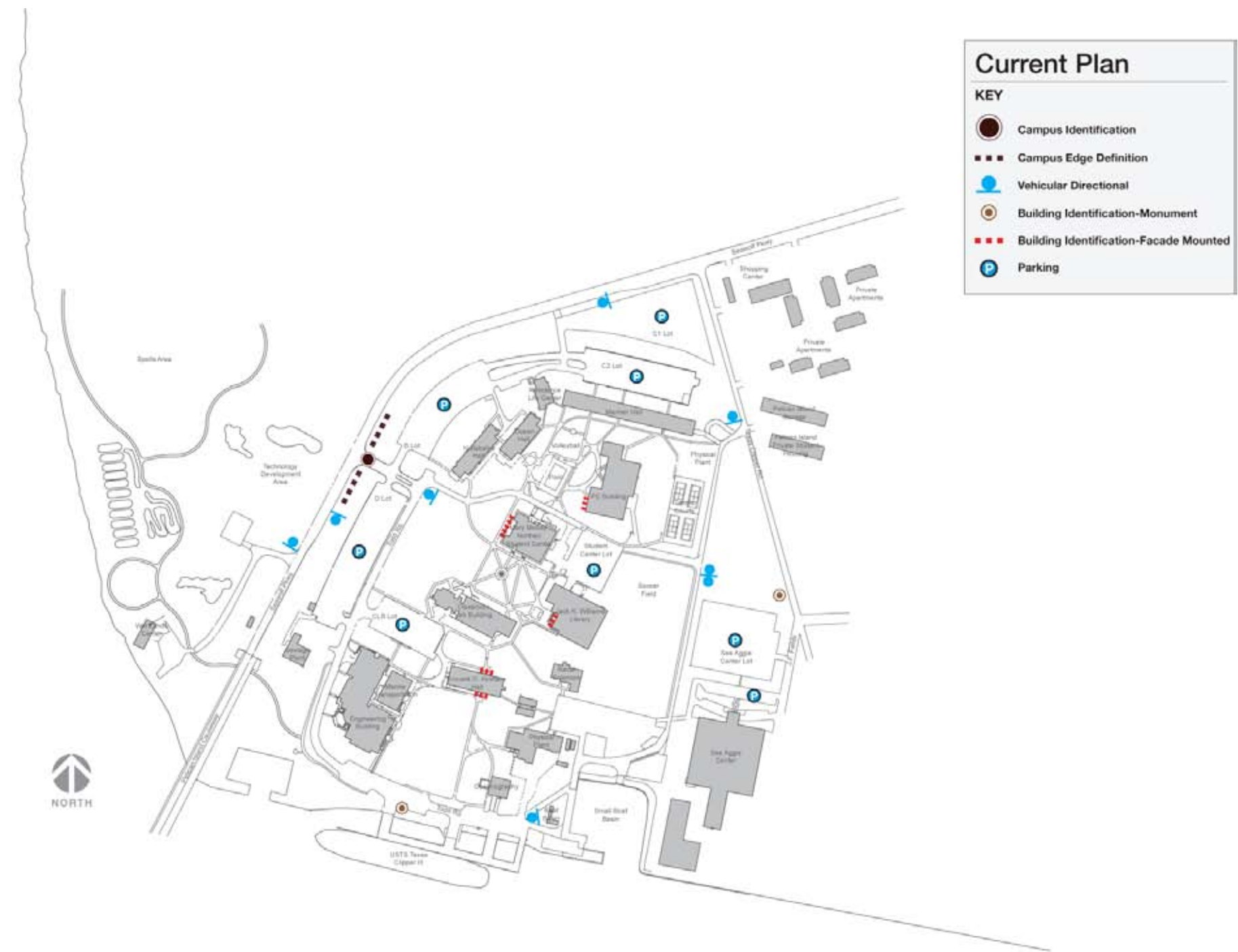

Wayfinding: Introduction



The goal of this Wayfinding Master Plan is to outline recommendations for the Texas A&M University at Galveston campus that are tailored to its specific needs and culture, and mindful of its anticipated growth—both geographically and population-wise. This plan is based on site surveys, virtual and in-person meetings with campus stakeholders, and coordination with the Master Plan architect and design team, as documented in the previously submitted Existing Conditions Report.

The wayfinding strategy should employ signage and other environmental graphic components to disseminate information that is visually accessible, concise, and easy to remember. In adhering to these design principles, the campus will establish a stronger sense of place and its visitors will experience a more inviting arrival.

Our wayfinding recommendations trace a visitor or prospective's journey to an on-campus destination:

1. Provide students and visitors directions prior to their departure; as examples, via the web site and accompanying pre-admissions materials.
2. Make navigation to the campus as intuitive as possible by providing clear cues at key points along the way.
3. Define the campus boundary by leveraging existing features and augmenting them with landscaping, signage, and lighting.
4. Clearly identify and differentiate campus entrances to support parking strategies per long-term growth plans.
5. Implement a well-designed, comprehensive signage system that addresses students and visitors once they are on campus.
6. Make it easy to find the correct parking lot and building.
7. Develop an accurate and user-friendly campus map and distribute it liberally.
8. Enhance the sense of place with signage and other environmental graphic components in concert with architecture, landscaping, and lighting.

Drawing from the initial site analysis and wayfinding best practices, this campus wayfinding strategy contains a summary of our recommendations with corresponding sketch-level documentation of possible applications and plans for implementation based on campus expansion over time.

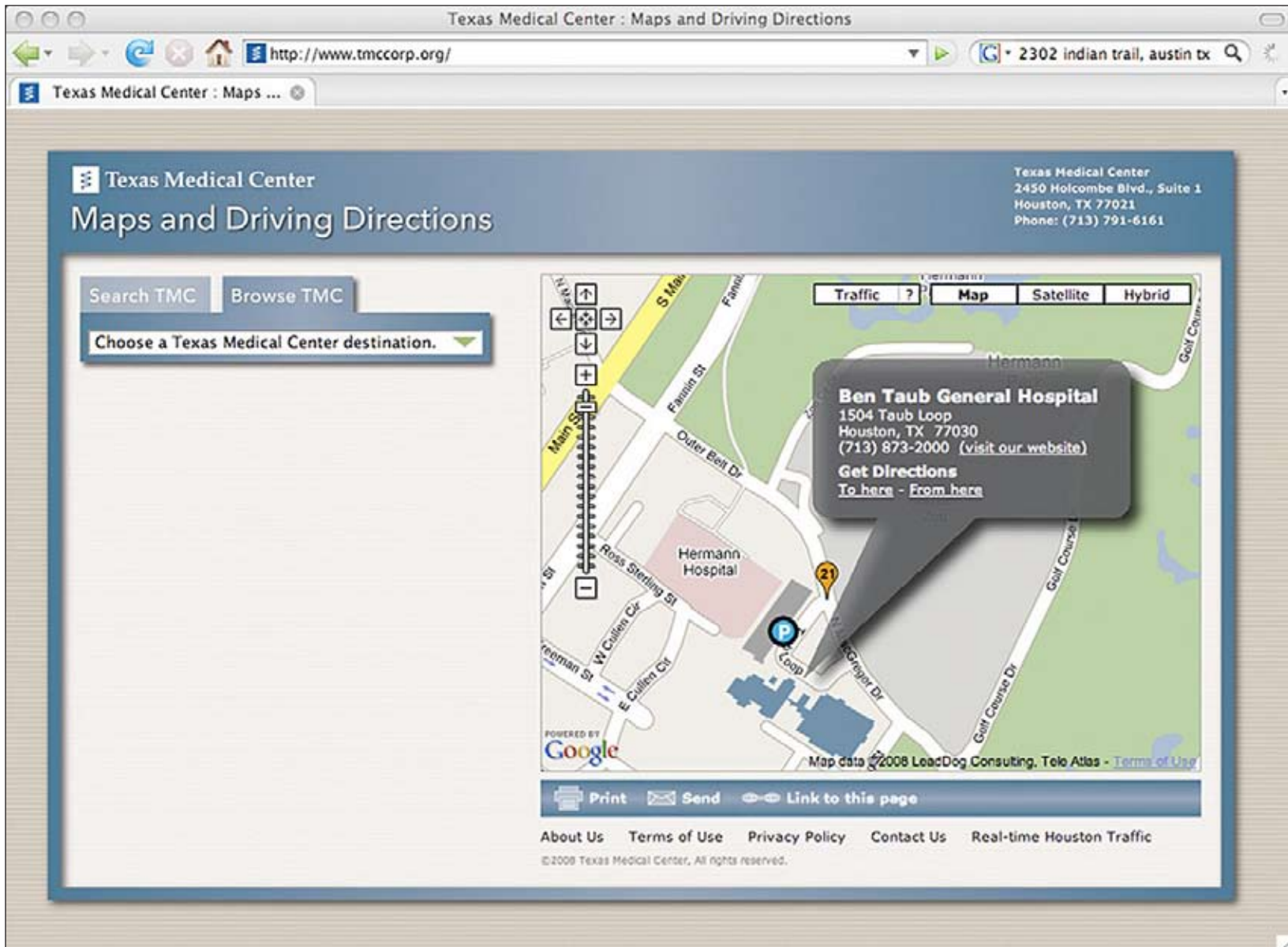

Wayfinding website reference

Wayfinding: Website

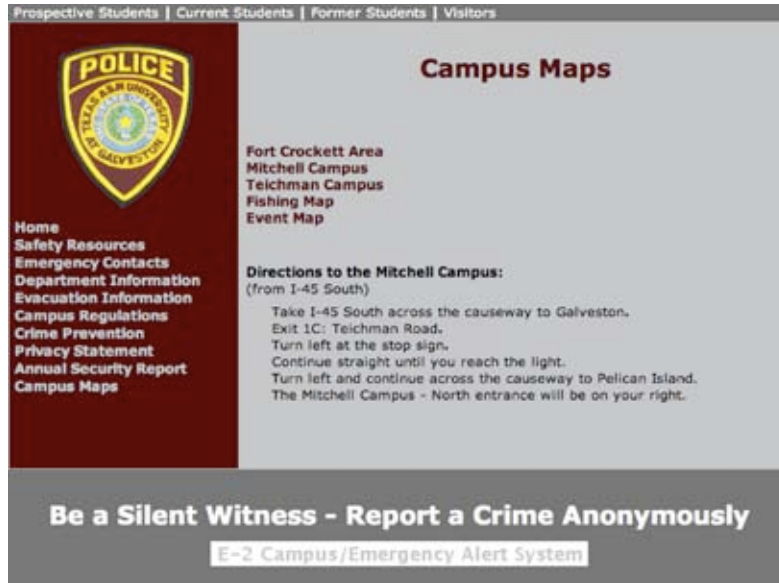

Existing online maps

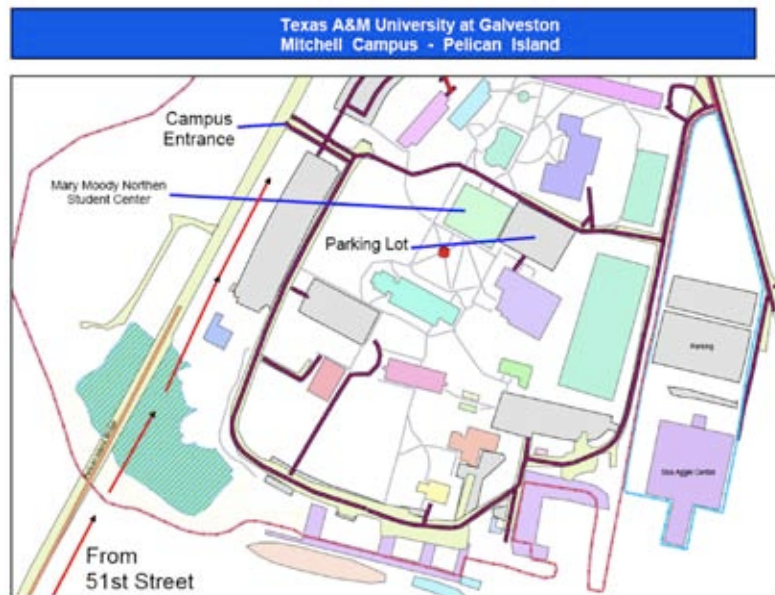

Existing online maps

Most university web sites offer wayfinding information such as campus maps and directories, but these critical materials are often “buried” within the site’s architecture. On the Texas A&M University at Galveston (TAMUG) web site, maps and driving directions are located under the catch-all heading of “About TAMUG” and further confuse visitors when they learn there are actually three Texas A&M-associated sites in Galveston (two are public, one is a research facility). There is also confusion about the name of the campus since it is referred to by different groups as Texas A&M Galveston, TAMUG, Mitchell Campus, and informally, as Pelican Island.

The TAMUG web site should have a clearly identified wayfinding component that requires no more than one or two “clicks” to access maps and driving directions. Maps should be simplified, accurate site diagrams with rigorously consistent naming conventions for the campus, mass transit and shuttle stops, entrances, parking, buildings, and departments. In fact, the maps available from the campus web site should match those found on campus signage and hand-outs.

Driving directions should consider primary and secondary routes and refrain from using local references for major roadways and streets, and instead repeat designations as they appear on highway and municipal signage. These public-facing maps should be distinct and separate from maps intended to communicate information for internal groups such as building and materials maintenance, security, and life-safety staff.

Since TAMUG’s population is comprised of students from around the nation and the world, their first impression of the campus is likely via the web site. By incorporating interactive links to maps and directions, visitors can plan for trips in advance. Clear communication of the proper and most efficient navigation sequence to and around the campus, beginning on the web site, also conveys the sense of order and self-reliance that is a hallmark of the Texas A&M University System.

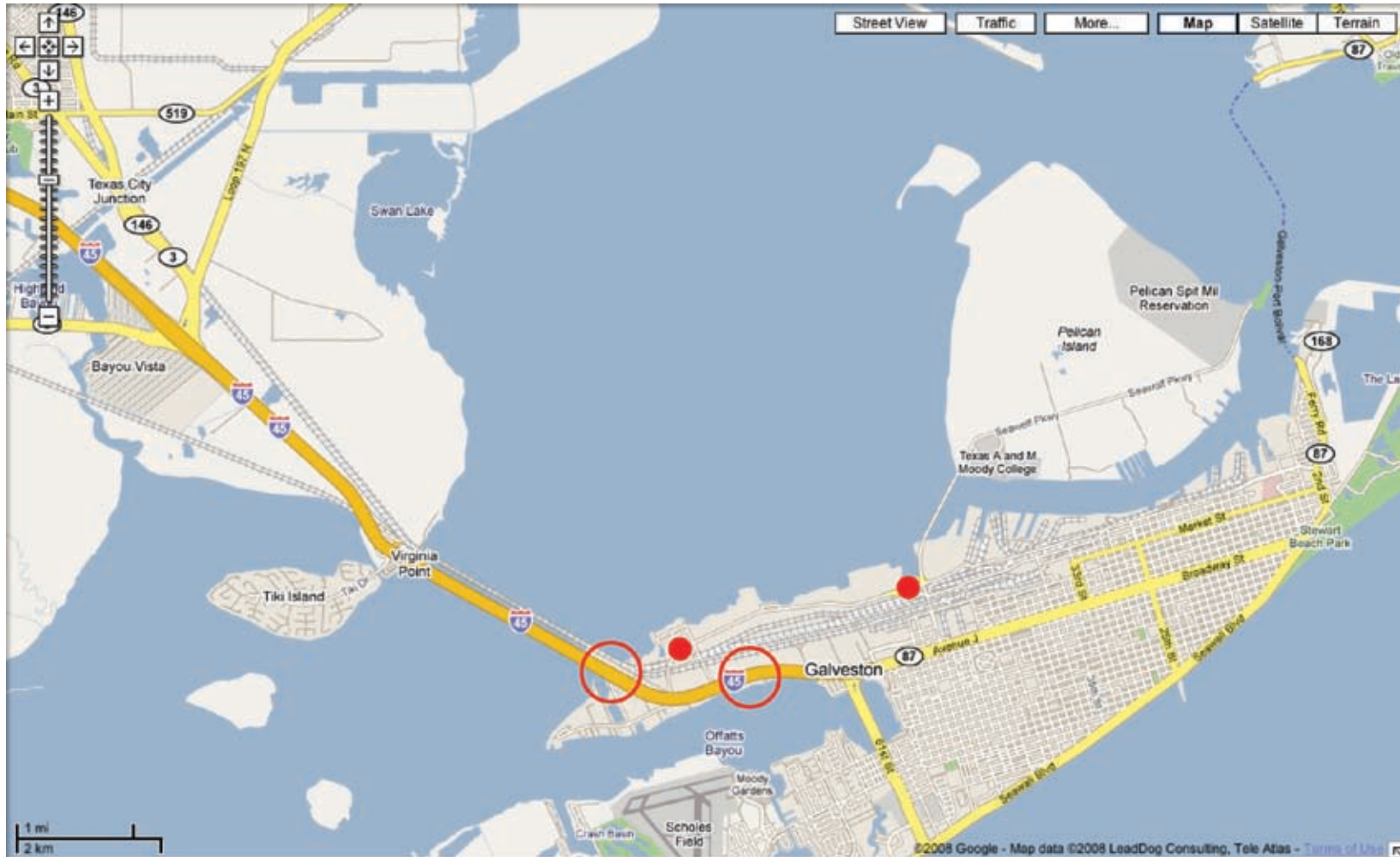

Directional signs for campus

KEY	
	Proposed Highway Sign Location
	Proposed City Sign Location

Wayfinding: Highway Signage



Island location



Causeway approach

Access to the Texas A&M University Galveston campus is almost exclusively via Interstate 45, via the exit for Harborside Drive. The university should therefore make use of the Texas Department of Transportation (TxDOT) highway signage system, for both northbound and southbound motorists on I-45, to assist visitors in finding the campus front door. It is understood that the present student population of TAMUG may not entitle the campus to directional signage along Interstate 45, but in light of the projected population increase for the campus, this dialogue with TxDOT should begin as soon as possible. To this end, a compelling argument may be made in the short term that the campus' relatively obscure location might warrant highway signage to ensure the more efficient arrival of visitors to campus, alleviating likely congestion further into the city of Galveston.

City of Galveston municipal signage should serve as secondary directional components that augment the TxDOT signage at key intersections along the primary arrival route. Large, clear signs that display the official, consistent campus name should be located on eastbound Harborside Drive (aka, Water Street; aka, Port Industrial Boulevard) in advance of its intersection with 77th Street and in advance of the intersection of Harborside Drive and Seawolf Parkway (aka, Pelican Island Causeway) to address all points of arrival.

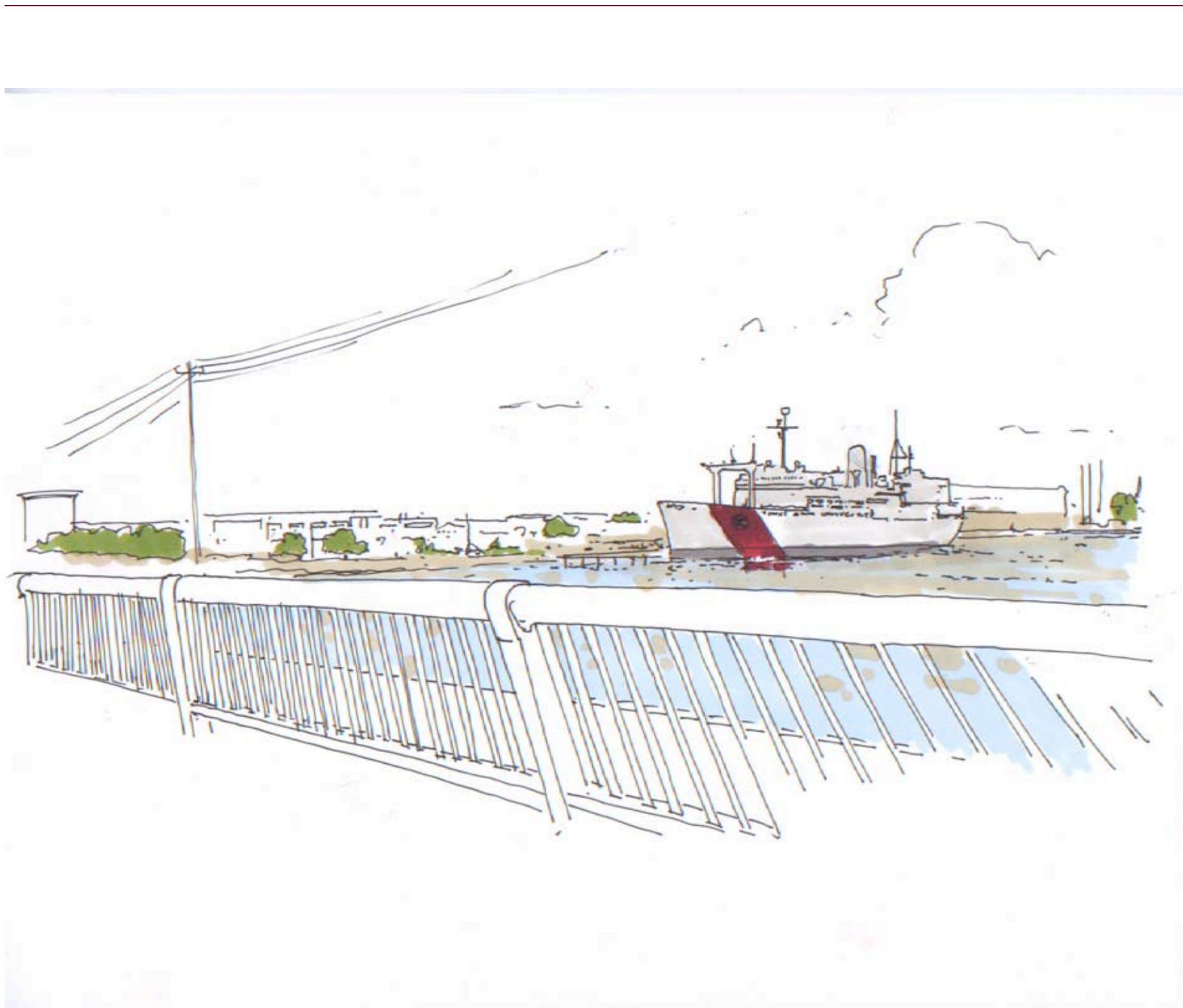

Wayfinding: Campus Approach and Edge Definition



Boat basin



Existing ship livery

The relative remoteness of the Texas A&M Galveston campus necessitates a more conspicuous sense of arrival, and the Texas Clipper III serves as a wonderful identifier because of its scale and its relation to the university's maritime focus. The vessel, located at the leading edge of campus and dynamically situated to command views from the Pelican Island Bridge, serves as a strong visual landmark for the campus, and would benefit from a more conspicuous, yet tasteful and appropriate livery. A simple band in the school color with the university seal would serve as a complement to the existing painted center stack.

Galveston Bay distinctly marks the southern and eastern edges of the campus, but to the north and east (along Seawolf Parkway), the domain of the university is less defined. Sizable concrete blocks, linked by chain, frame the main entrance to campus and convey an appropriately nautical theme, but should be augmented with pedestrian walkways, landscaping, articulated curbs, and lighting to reflect a special character that is distinct from the otherwise industrial character along Seawolf Parkway. As the campus and its population grows, planning for and developing these amenities will not only help define the campus, but also support pedestrian activity befitting a vital learning environment.

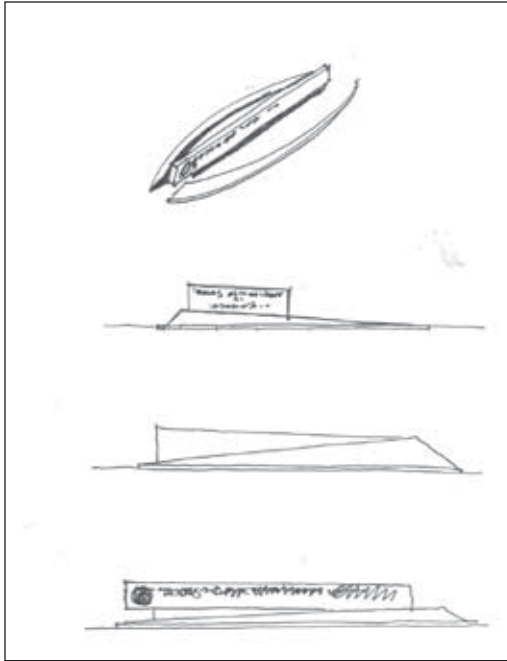

Main entry sign form studies



Main entrance

Wayfinding: Campus and Entrance Identification

Campus identification must create a strong sense of arrival, and current sight lines suggest this can be accomplished, especially when the campus' edges have been well defined leading up to the entrances. Conspicuous signage coordinated with a well-conceived landscape, hardscape and lighting scheme can provide a focal point that will help welcome and orient first-time visitors. Vertical elements, such as palm trees and light pylons, that frame entrances can also serve to alert visitors to upcoming entrances.

The west entrance serves as the primary functional and ceremonial access point by vehicle to campus and should therefore be distinguished with appropriately-scaled identification.

In the near-term, the north entrance to campus will continue to serve as an entry point to prospective students and visitors and should be identified accordingly. Entrances are currently identified as "Main Entrance" (west) and "North Entrance" (north), but it may be advisable to identify these entrances by street names; for example, Sea Aggie Boulevard (presently Main) and Texas Clipper Road (presently North). This would leverage an existing street name for the north entrance and reference the university culture in highly visible way for the main entrance; in effect, helping to build infrastructure and acknowledging the planned extension of the main entrance drive across Seawolf Parkway.



North entrance

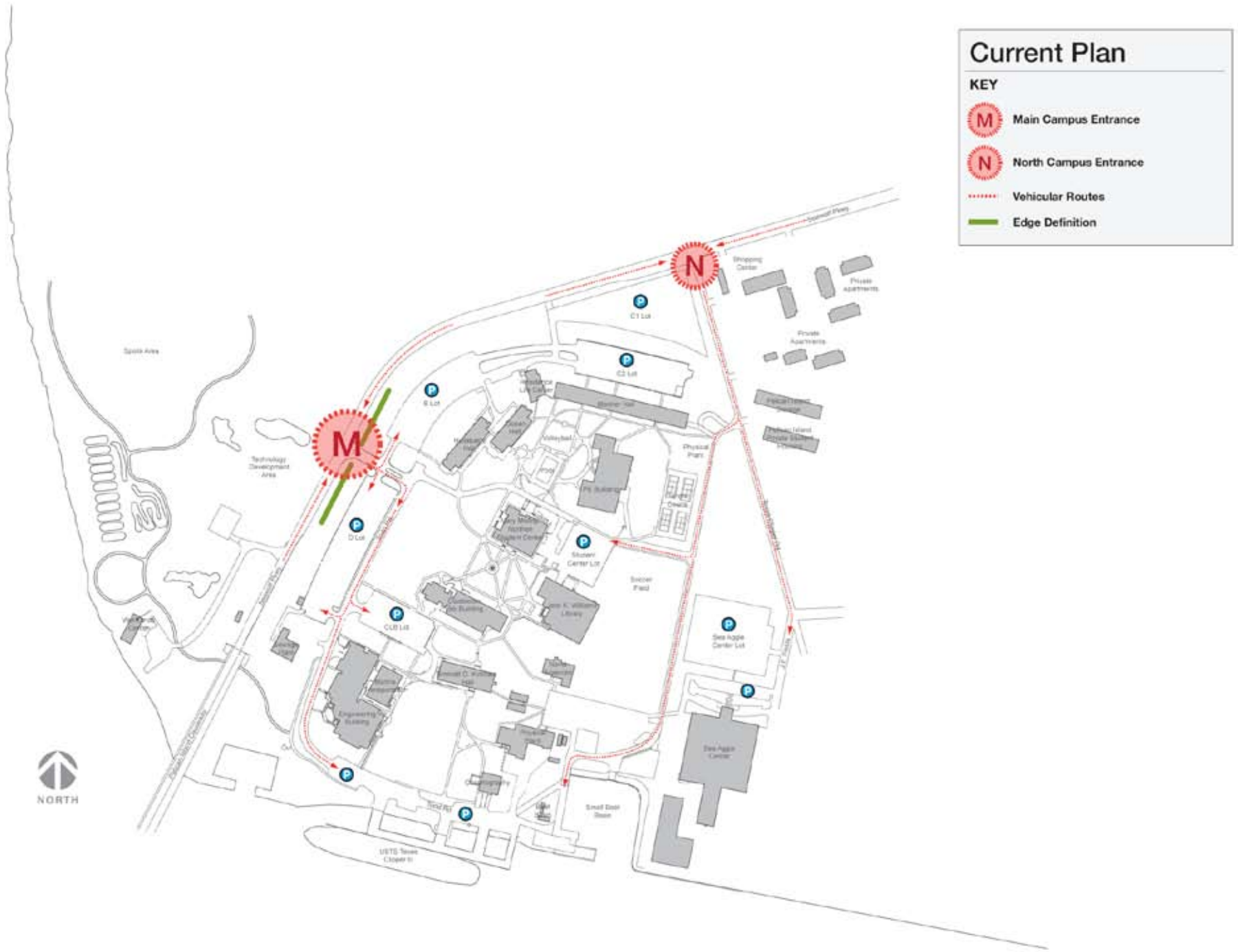

Current Plan

KEY

-  Main Campus Entrance
-  North Campus Entrance
-  Vehicular Routes
-  Edge Definition

Wayfinding: Entrance ID and Edge Definition

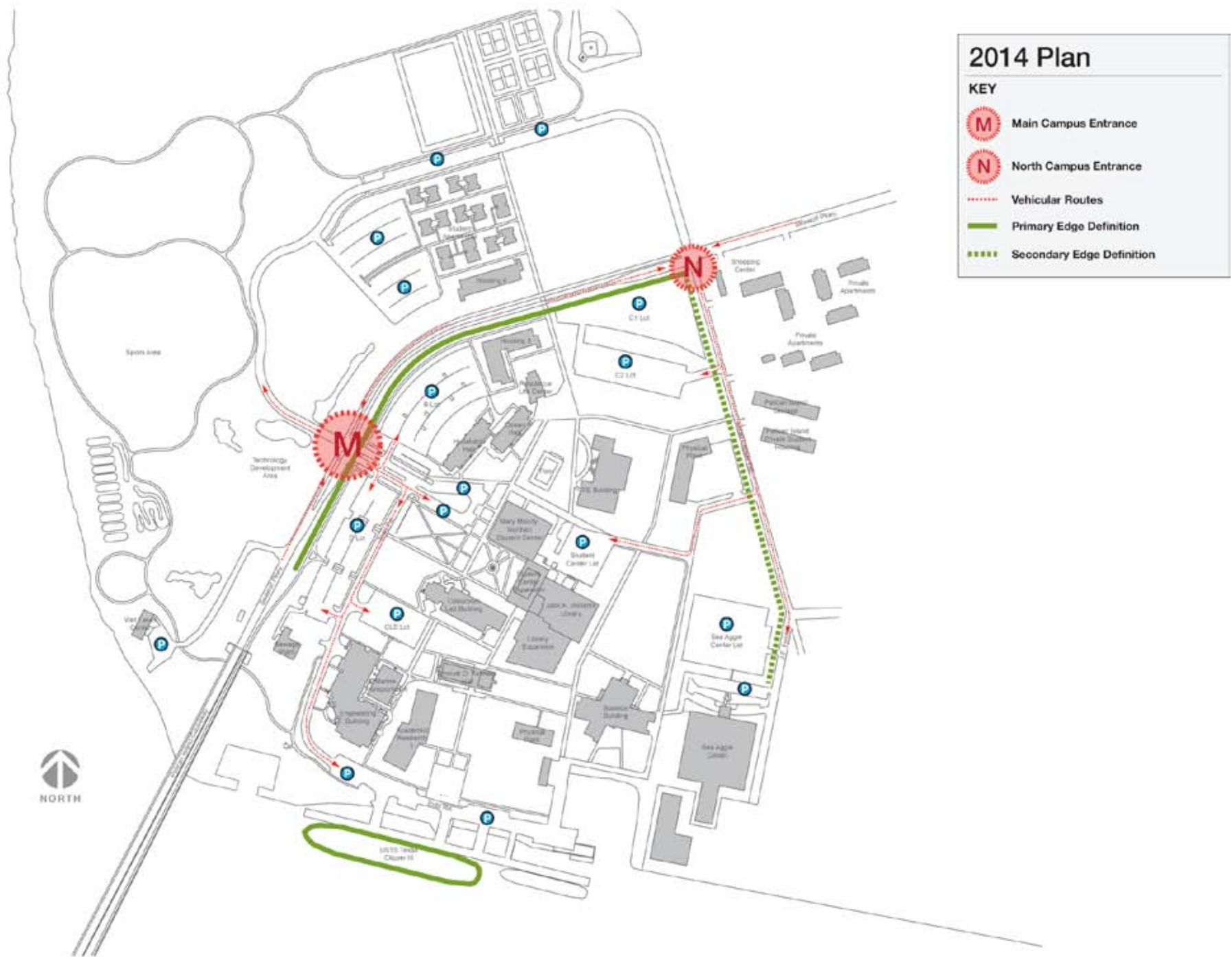

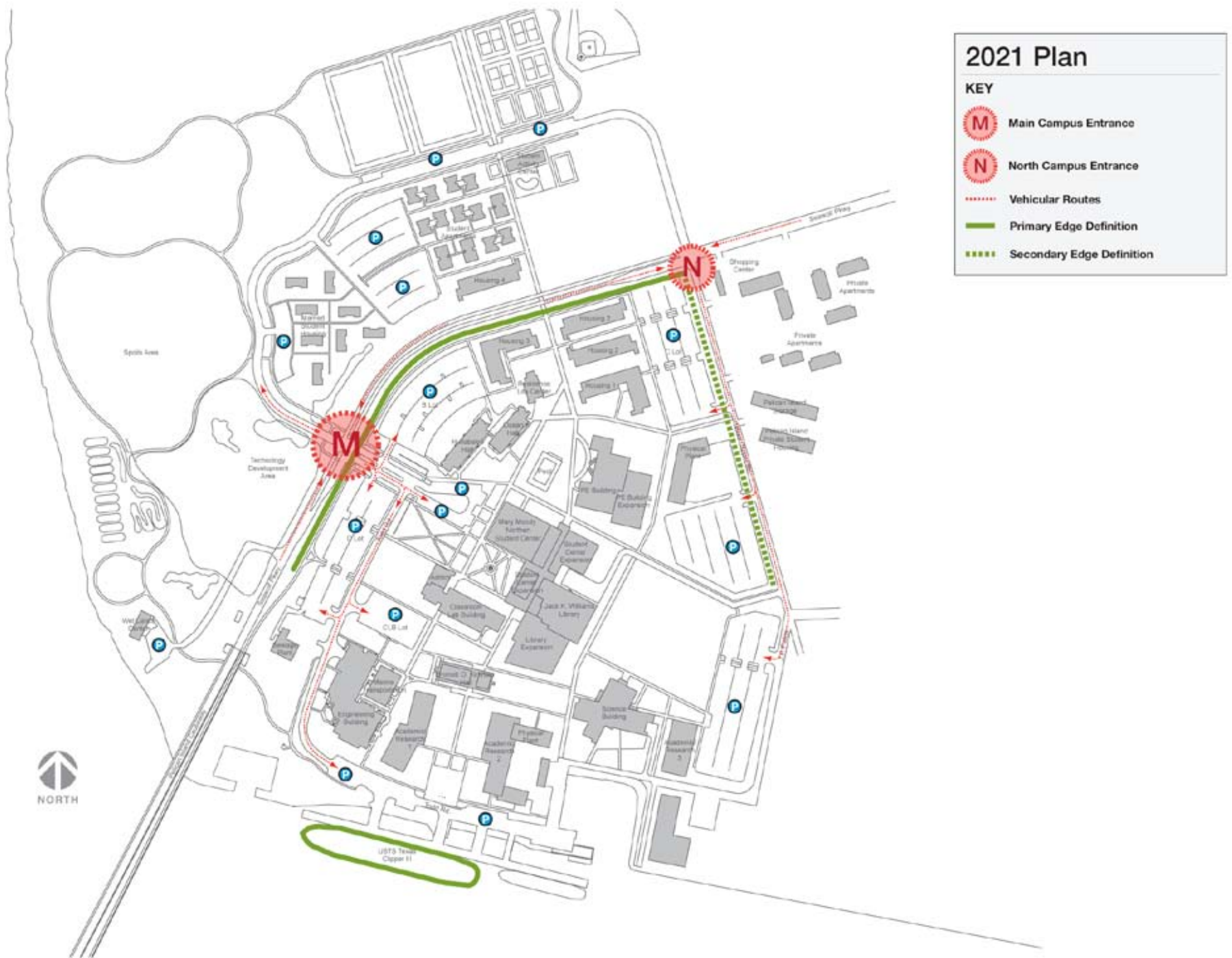

2021 Plan

KEY

- Ⓜ Main Campus Entrance
- Ⓝ North Campus Entrance
- Vehicular Routes
- Primary Edge Definition
- Secondary Edge Definition

Wayfinding: Entrance ID and Edge Definition

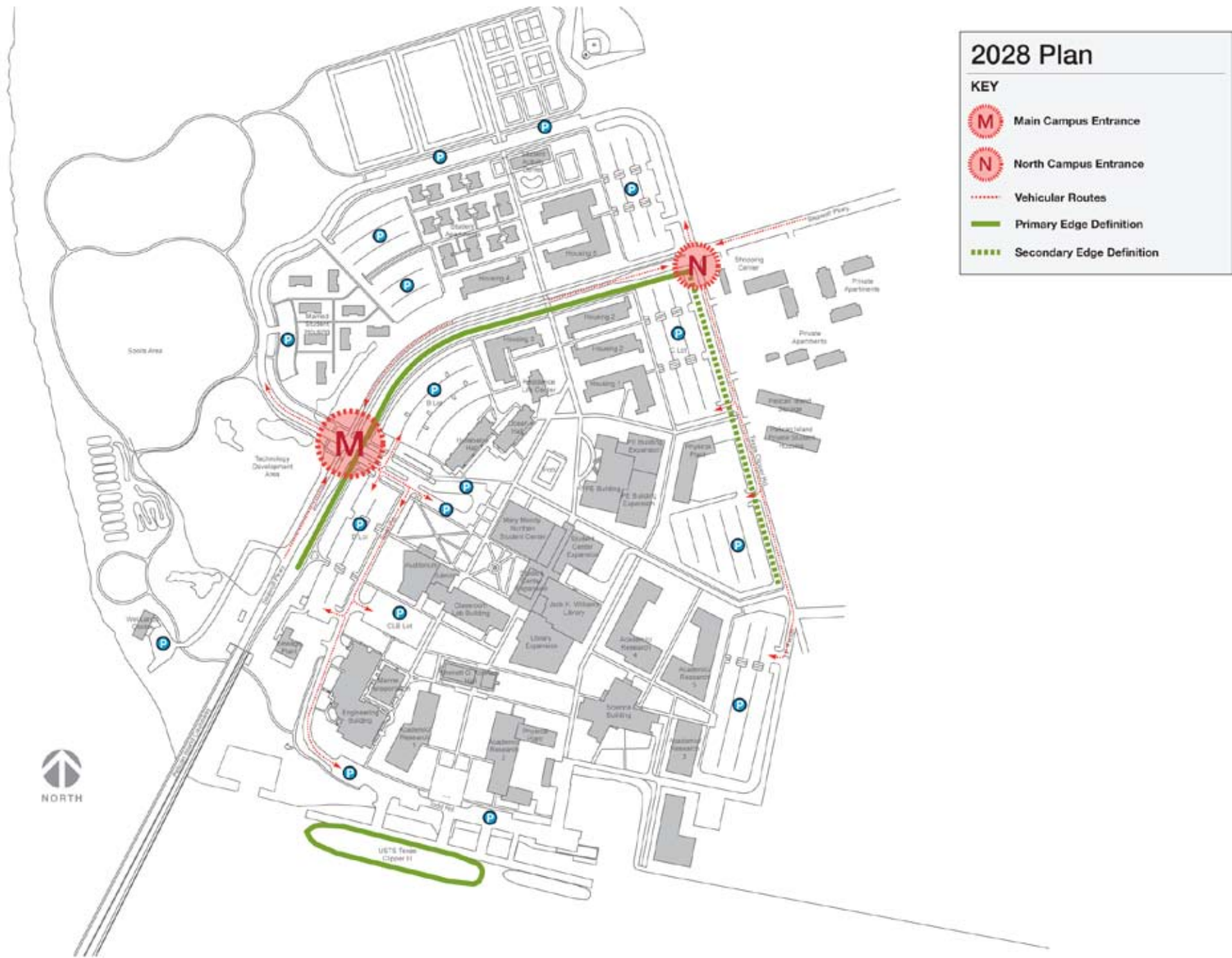

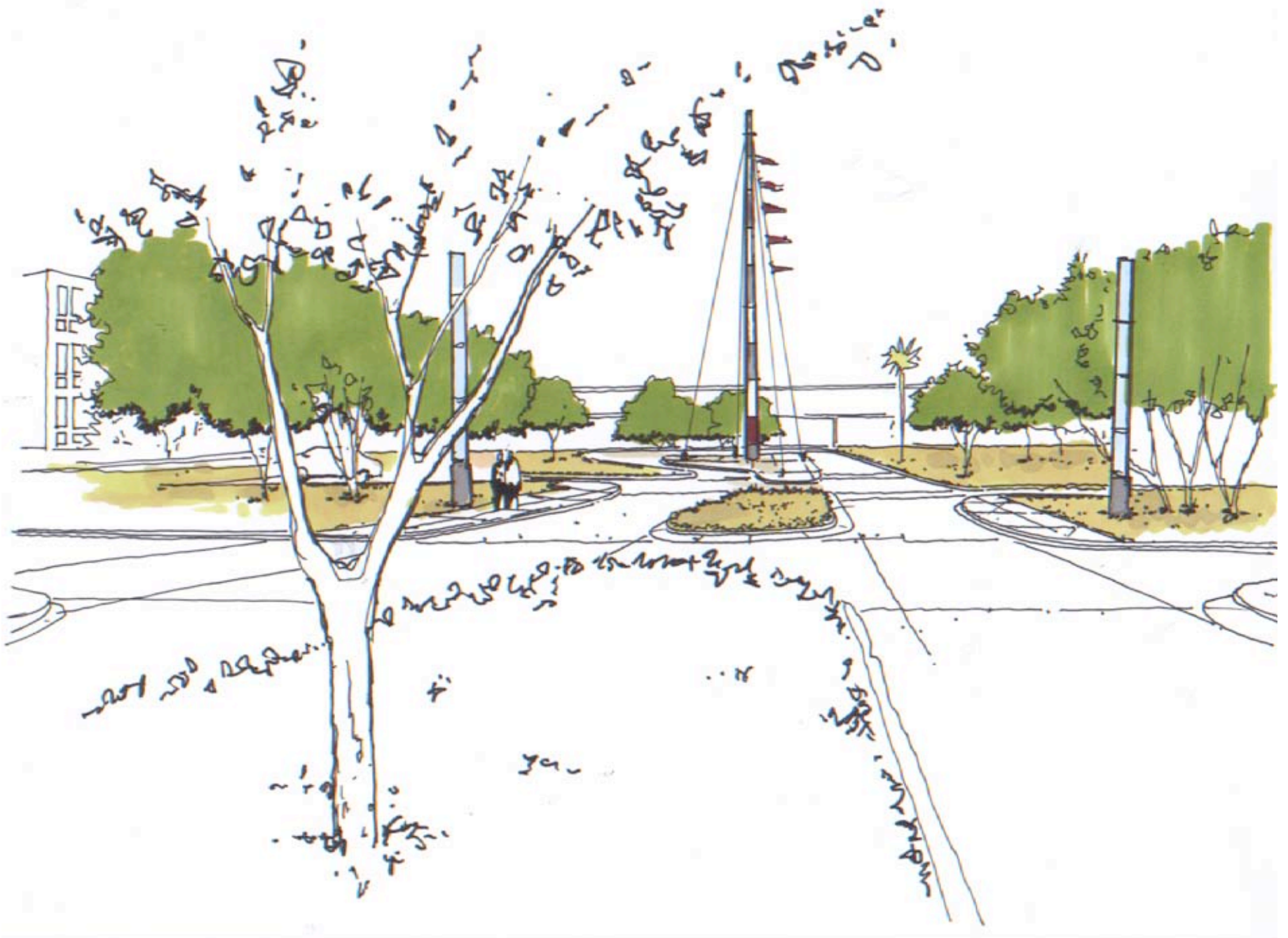

Main drop-off feature

Wayfinding: Motorist Orientation



Parking ID

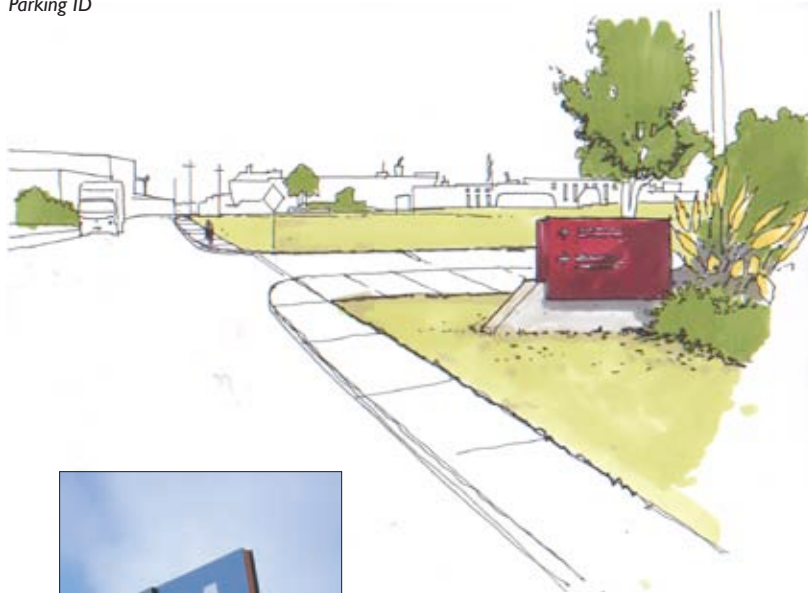

Vehicular directional



Parking ID reference

As the Texas A&M Galveston campus continues to grow, it will become even more important to implement a comprehensive family of signage and environmental graphic components that include vehicular directionals that guide motorists to campus entrances, parking areas, and special events. Clearly identifying parking areas with signs that display the lot designation as well as its intended use for staff, visitors, and students is vital as well—especially as the resident student population increases. Cross-referencing these parking area designations with parking information available on the university's web site and printed information on parking permits (both long-term and day permits) will ensure that students, faculty, and visitors are properly oriented to parking.

Signage directing motorists to, around, and through the campus should carry no more than a few consistently-presented destinations. These signs will direct primarily to campus entrances and parking areas, since most motorists will park and walk to their destination. Vehicular signs should also be scaled appropriately to the roadway they serve and to the speed of traffic. These signs can also be conspicuous components of the campus infrastructure, conveying a desired aesthetic. At certain key locations, directional signage might accommodate temporary messages to direct visitors to special event parking in more tidy fashion than ad-hoc temporary signage and postings. Operational and regulatory signs on campus, such as speed limit notices, restricted parking, and fishing information should be standardized and mounted to a campus-standard pole to convey a sense of order and continuity. A well-articulated, functional, flexible, and tasteful site signage system will allow motorists to more easily navigate the campus, yielding a more efficient experience for the visitor and a safer environment for everyone.



Pedestrian building ID



Building ID reference

Wayfinding: Building Identification

Unless there is a compelling reason not to remove the current facade-mounted sign panels that display a four-digit inventory number (some also include an alphabetic suffix) for each building, these panels should be removed and replaced with facade-mounted individual letter forms that identify the functional name of the building, as well as the donor's name as appropriate. If, in fact, the building inventory designation must be maintained, it should be displayed as a secondary component, subservient to the functional building name. Good examples of existing facade mounted building identification letter forms found on campus are Kirkham Hall and the Physical Education Facility. A campus standard for building identification letter forms should be developed to standardize scale, mounting orientation, illumination, color, material, finish and visibility at a distance, with emphasis on addressing existing and anticipated sight lines from adjacent parking areas and pedestrian approaches.

Freestanding building signs of at least two different sizes should augment the building mounted letter forms. The larger of these building identification sign types should be situated in a way that

visually relates to the building that it is identifying, and presents itself more clearly to the perimeter of the campus since this is the vantage for visitors arriving on site and parking. These signs will be especially helpful in identifying buildings whose entrance(s) are inboard to campus. Optimal orientation of these signs is perpendicular to primary lines of sight for motorists. A smaller scale building identification sign would serve pedestrians primarily, so it will most often be placed on the sides of buildings facing into the campus core and along pedestrian routes, in closer proximity to primary entrances to the building.

Well-placed building identification signage, whether building-mounted or freestanding, will help visitors identify buildings at a greater distance. And while the architectural character of campus buildings differ somewhat (and will continue to do so as the campus grows), establishing conventions for how the buildings are identified will go a long way toward providing clear information in a consistent and aesthetically pleasing manner.



Pedestrian building ID



Commemorative graphic panels

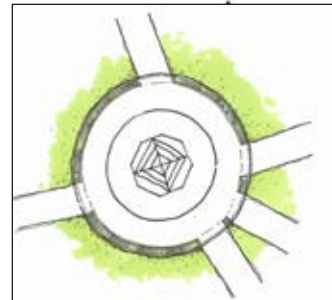

Wayfinding: Pedestrian Orientation and Placemaking

At first glance the physical scale and layout of the Texas A&M Galveston campus seems easily navigable. However, at pedestrian eye level, many of the buildings look similar, which undermines a visitor's orientation. There is a strong north-south axis that affords pedestrians access to most of the buildings on campus, so locating campus maps and corresponding directional sign panels at strategic points along this axis will help alleviate potential confusion. These sign elements can also accommodate colorful banners and display cabinets for postings to support student activities, encourage school spirit, instill a stronger sense of place and reinforce a growing campus infrastructure.

These orientation signs, like trail head signage, will also help mark the beginning and terminus of primary pedestrian paths, helping to transition information for motorists turned pedestrians. Messaging on these signs, as presented in maps and on directional signs, should be rigorously consistent with information found on the university's web site, displayed on building identification signage, and communicated by campus staff and students. Pedestrian-oriented signage, more so than vehicular directionals, can support more information, but messaging should be distilled to a minimum for ease of use. Parking areas and roadway names should be indicated on maps to help visitors return to their parked vehicle or point of origin. TAMUG has

several existing landmarks, namely the waterfront and Texas Clipper III, clock tower and USTS Texas Clipper anchor, that should be leveraged on maps and perhaps depicted as icons. In the case of the clock tower, given its central location on campus and potential as a gathering place, an interpretive display that engages the structure at its base and heralds the campus' history and mission could serve as a wonderful point of orientation for visitors, prospective students and their parents.

Pedestrian orientation signage and leveraged visual landmarks present opportunities for grouping amenities to create memorable on-campus meeting spots. Coffee carts, shade structures, bicycle racks and seating are additional amenities that can enhance these spaces and elevate the quality of on-campus life. And since the campus' focus is on research and leading edge technology, the potential for introducing interactive kiosks at high-traffic locations that can orient students and faculty beyond the boundary of the campus should be a consideration. These kiosks can replace or complement static campus maps and directories and promote interest in school activities or even local businesses, supporting a connectedness between the university and its larger community.



Pedestrian directional

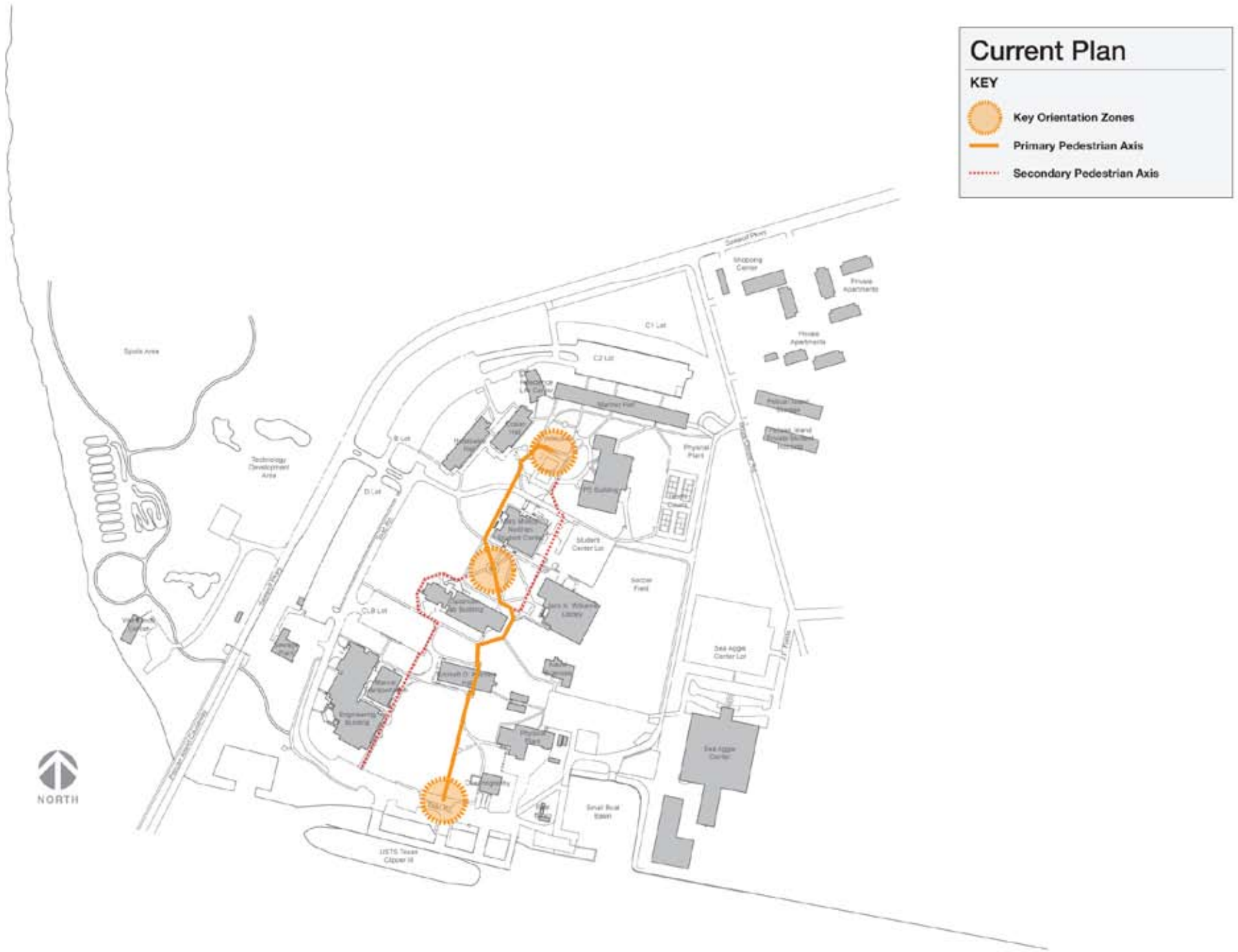

Wayfinding: Pedestrian Orientation

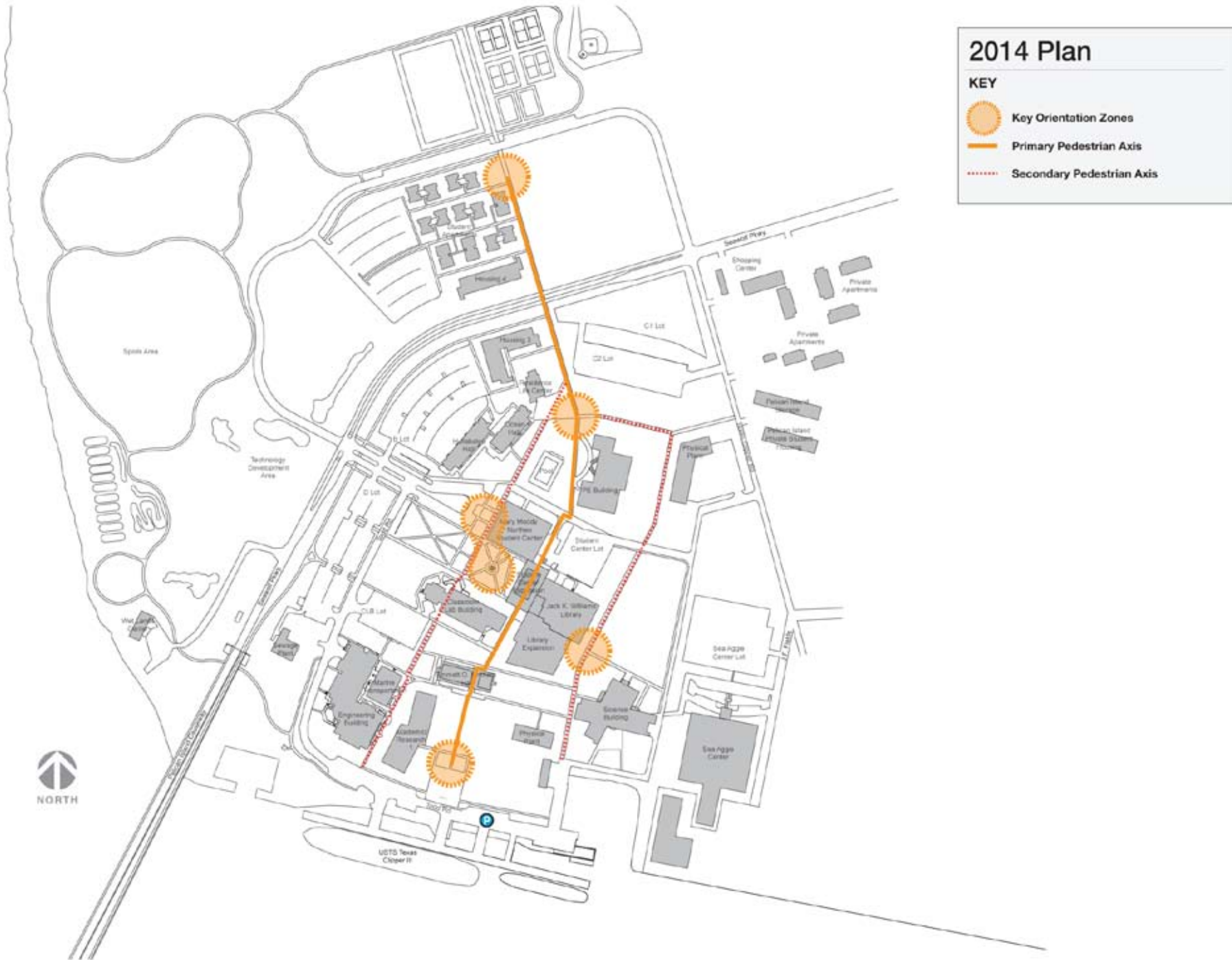

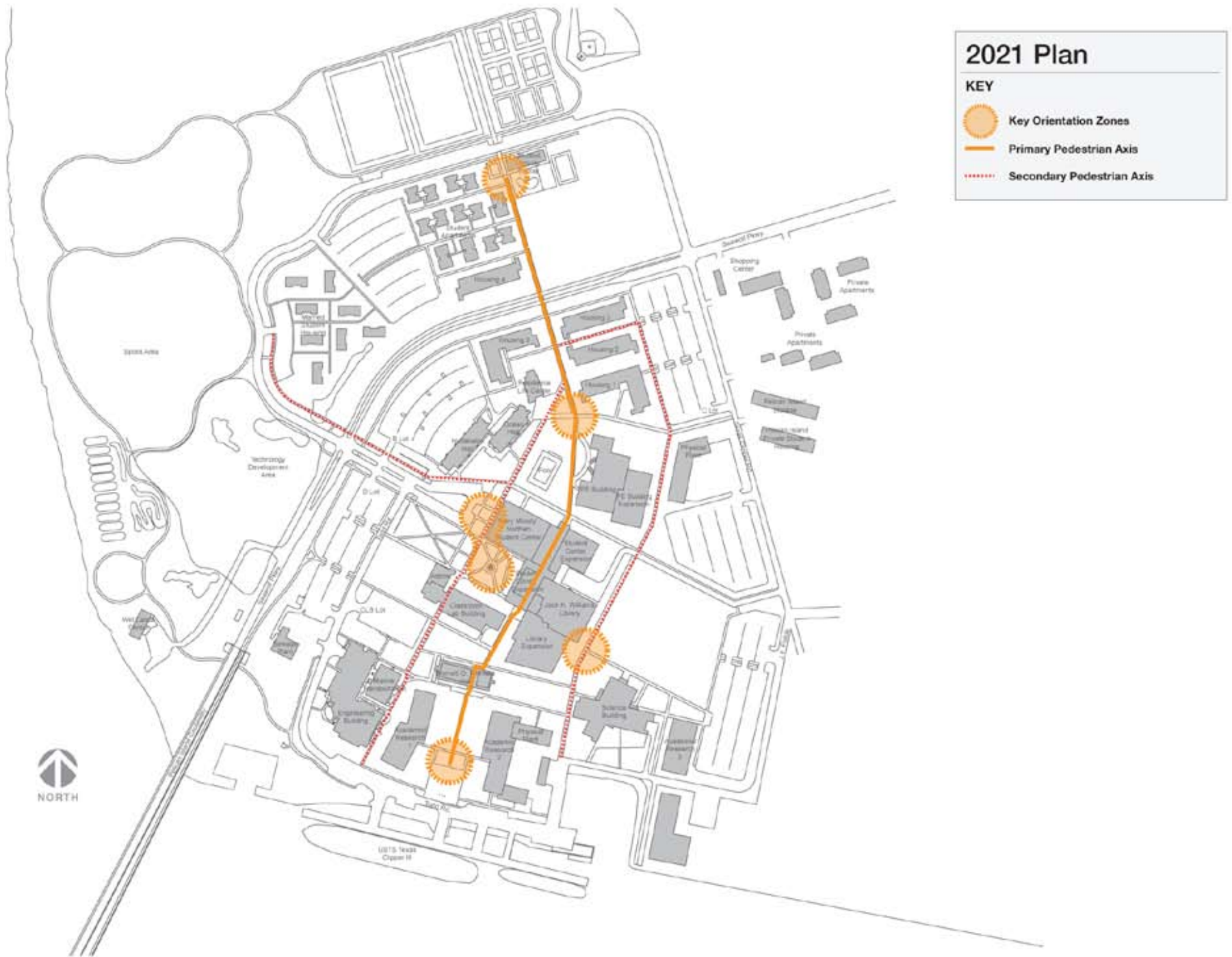

Wayfinding: Pedestrian Orientation

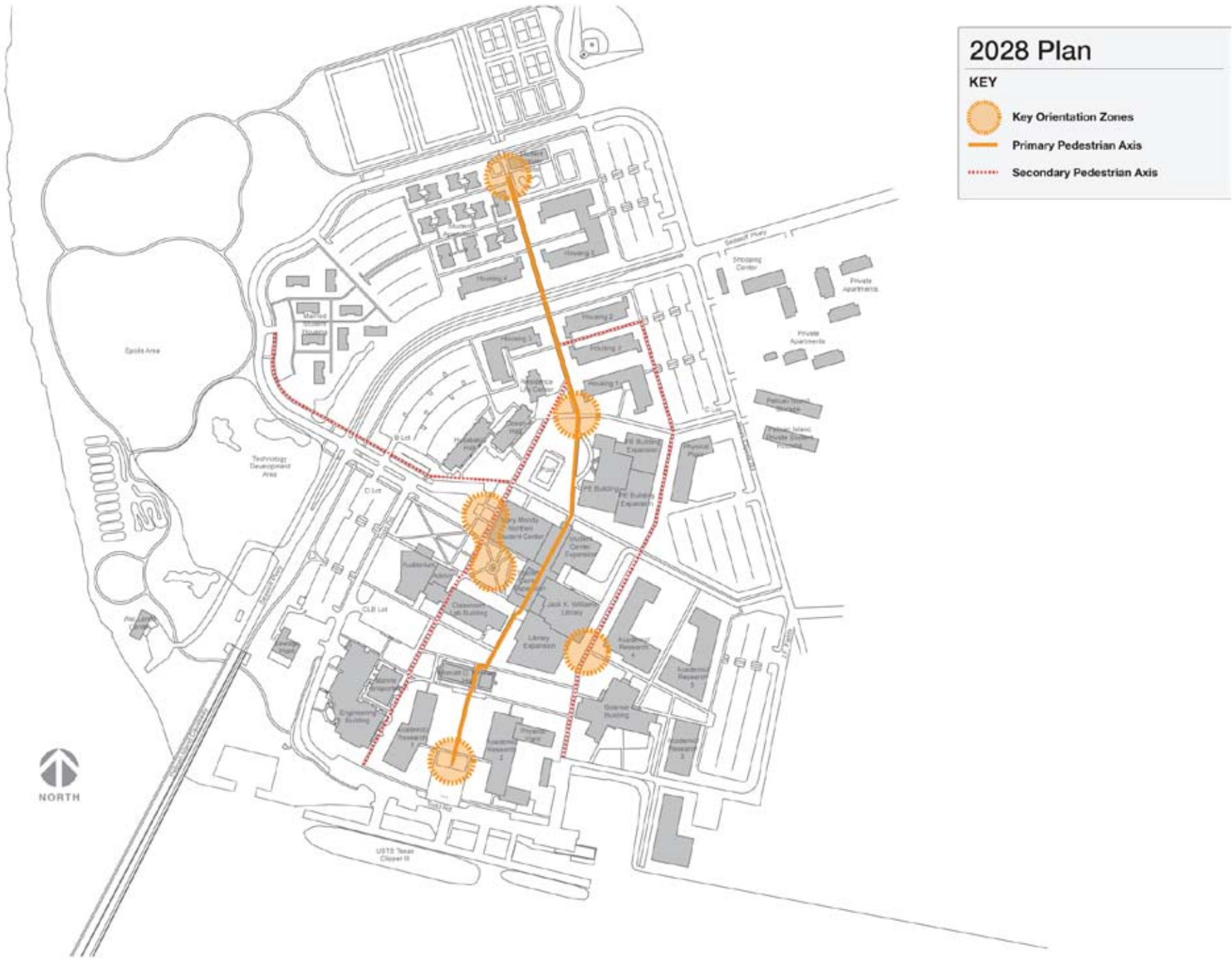

Wayfinding: Summary



This Campus Wayfinding Master Plan recommends a strategy for the Texas A&M University at Galveston campus that reinforces the university's image, promotes ease of navigation, and enriches the campus experience for everyone. It is important to note that wayfinding comprises more than signage; it should incorporate components like domain markers, sculpture, campus maps, printed information, and a wayfinding web site. At its best, effective campus wayfinding is the result of careful and deliberate coordination of architectural planning, landscaping, lighting and built elements to identify, orient, direct, regulate and inform its audience.

Beyond aspects of functionality like contrast and legibility, mounting methods and scale, the campus wayfinding components should convey the distinctive character of the university's island location. The design aesthetic of the physical components should make abstract if not overt visual references to this maritime setting and the larger context of Galveston Island (geographic) and the Texas A&M University System (institutional). Associated environmental graphic elements, like pageantry, landmarks, and kiosks, should help knit the campus to the waterfront and encourage activities along that front. Where appropriate, the wayfinding system components should lend a contemporary look to the campus while honoring its tradi-

tion and heritage. Since the general architectural character of the campus might best be characterized as visually heavy, environmental elements and signage should be comparatively light, with minimal footprints and armatures, fittings and connections evocative of a maritime culture. For example, cables, semaphores and mast-like support structures as elements of the design vocabulary would relate well to the setting and support a contemporary aesthetic.

Growth projections for the university suggest a significant increase in the campus population, which will pose an enormous challenge to wayfinding. As campus vehicular and foot traffic increases over time, wayfinding will need to address issues of safety and community as much as efficient navigation. The university should be vigilant to maintain a clear vision of how the various recommended wayfinding components are implemented in response to projected growth. To this end, the Wayfinding Master Plan presents a location strategy for major wayfinding sign types and environmental graphic components for the 2014, 2021 and 2028 campus master plans. These recommendations advocate functional and aesthetic considerations for campus wayfinding, and the university's commitment to these principles will support a navigable and cohesive learning environment.

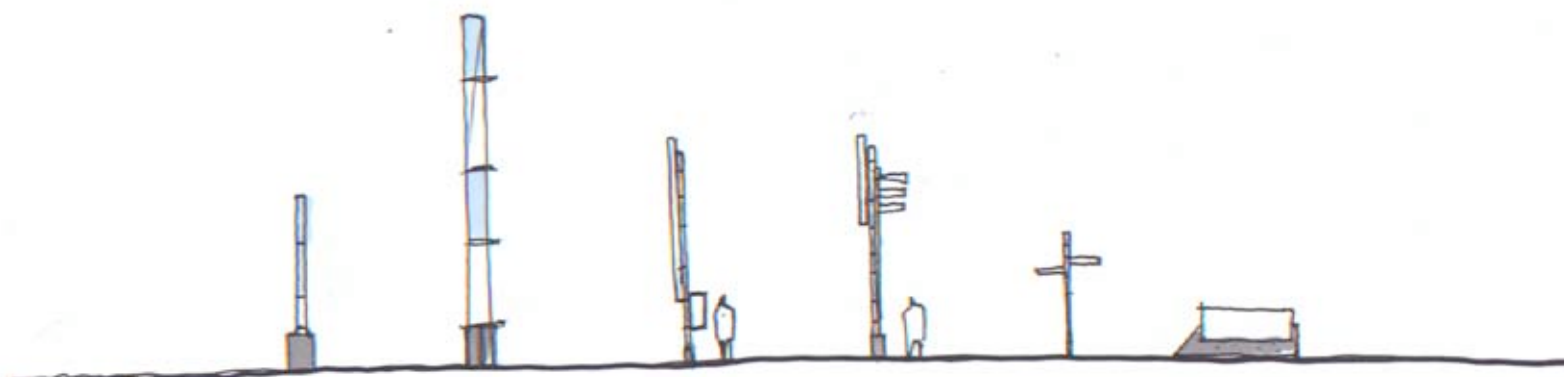











Wayfinding: Campus Signage Strategy



2014 Plan

KEY

-  Parking
-  Campus Entrance Identification
-  Campus Identification-Ship Livery
-  Building Identification-Pedestrian
-  Building Identification-Monument
-  Building Identification-Facade Mounted
-  Parking Lot Identification
-  Vehicular Directional
-  Pedestrian Directional/Orientation
-  Off-Property Sign Location



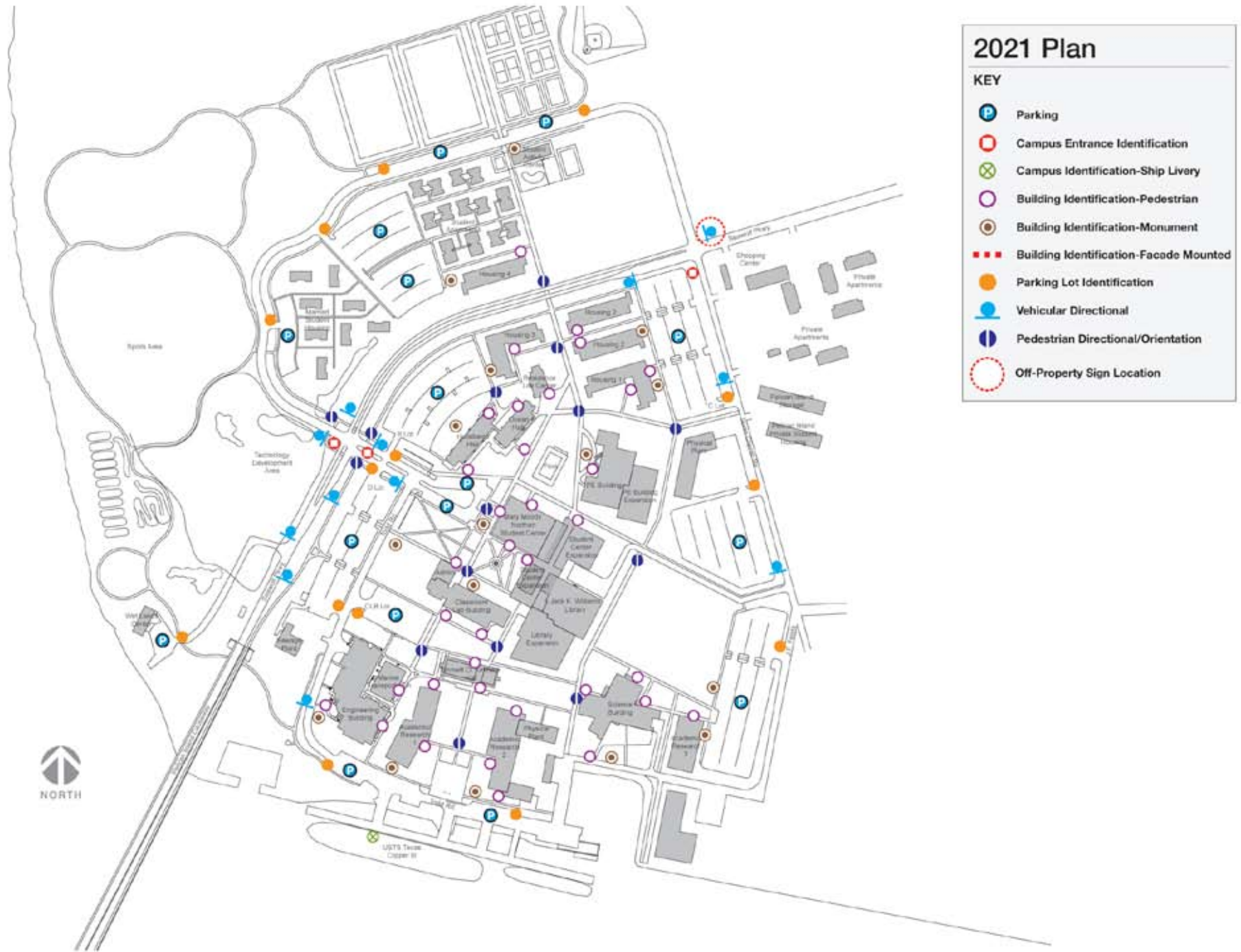

Wayfinding: Campus Signage Strategy

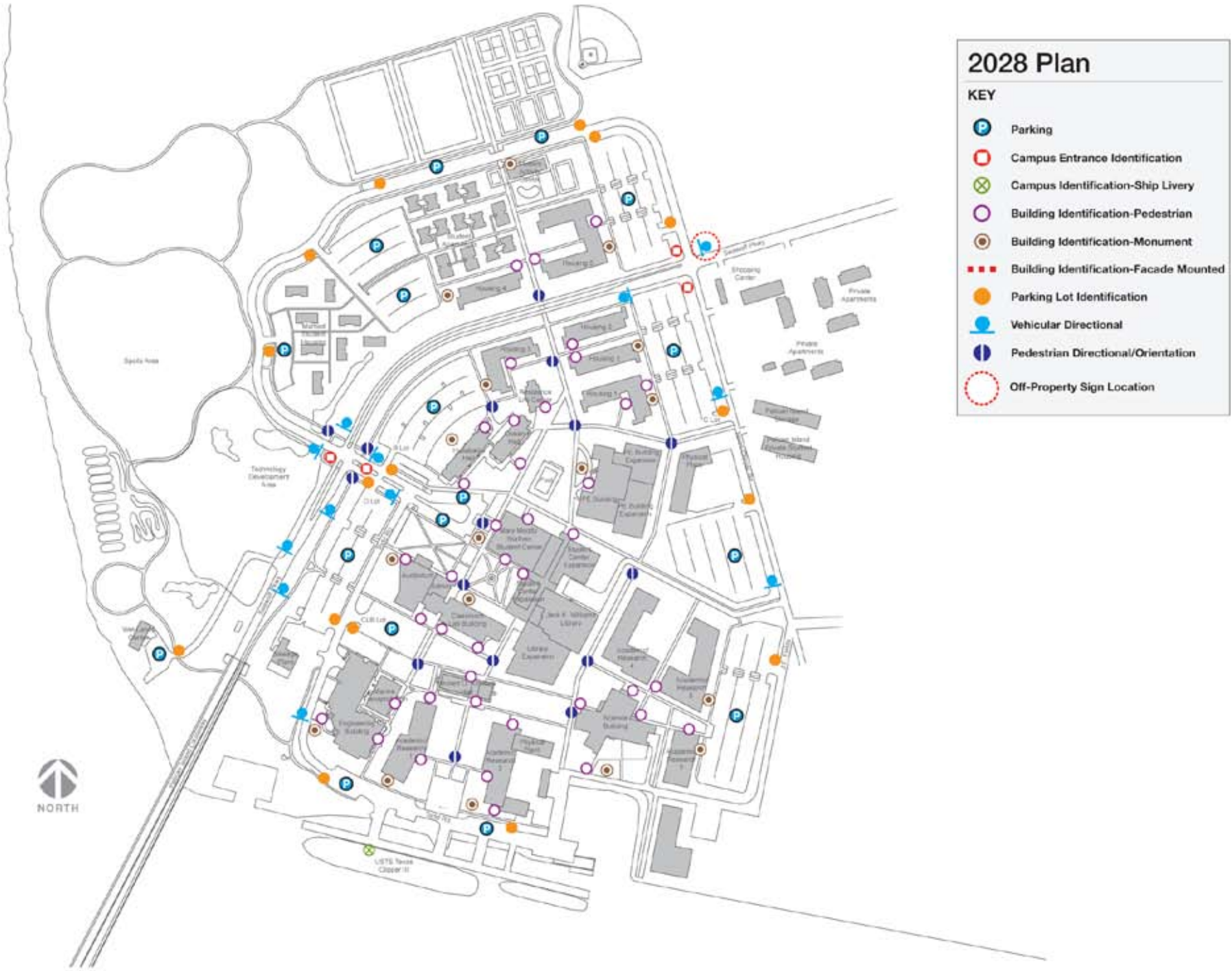

Existing Electrical Distribution System

The existing campus electrical distribution system consists of one 12.47kV circuit from Centerpoint Energy (CPE). It terminates in a two circuit breaker line up of metal clad switchgear on the TAMUG campus. The system is then routed to each of the buildings via an underground duct bank with a single #4/0 circuit.

At each building or transformer there is a loop switch that connects to the over all campus loop. The loop can be utilized to isolate an area of the campus should the feeder fail between buildings.

The circuit is rated for approximately 6,400 kVA. The existing connected load on the system is 8,700 kVA. The demand load on the system will be approximately 3,600 kVA after the new science building and central plant modifications come on line. There is some spare capacity in the circuit to add future buildings but not sufficient to serve the entire campus development.

Future Campus Development

The following additions are planned as the campus is further developed.

Housing	685 beds
Academic/Research	410,000 gsf
Administration	9,000 gsf
Auditorium	16,000 gsf
Wellness Center	21,000 gsf
Student Center	24,000 gsf
Central plant	2,700 tons of chiller capacity 17,500,000 BTUs of heating hot water

This development will add about 5,000 kVA of electrical system demand as the buildings are added. The existing electrical system cannot serve this much load. A new electrical distribution will be required for the campus build out.

New Electrical Distribution System

It has already been determined that the campus cannot be further developed with out the construction of a new central plant. As part of that new plant a new campus electrical service should be included. The new service point will be adjacent to the existing service point of Sea Wolf Parkway and will be routed to the new central plant. The new campus electrical distribution system will originate in the central plant. It will serve the new central plant the new campus buildings and ultimately the existing campus electrical distribution system.

The routing for the duct bank system should be included with the planning of the new thermal piping distribution scheme. Where new thermal lines are installed to serve new buildings the new duct bank should be routed

adjacent to the thermal lines. Where new thermal lines are connected into the existing thermal distribution system, the new electrical distribution system can be routed adjacent to the new thermal lines and connected into the existing electrical distribution system to allow the existing system to be upgraded. The new electrical distribution system will be routed under Sea Wolf Parkway as the campus is expanded.

Engineering: Electrical Systems



Thermal Utility Capacity at Existing Central Plant

The existing central plant provides cooling and heating for all buildings on campus via direct buried heating water and chilled water distribution lines.

Following completion of the new science building, the peak cooling load for the campus will be approximately 1,800 tons and peak heating demand will be approximately 6,000,000 BTUH. Upgrades to the chilled water system will increase total central plant capacity to 2,000 tons consisting of two 500 ton chillers and one 1000 ton chiller. The firm capacity of the plant, which is defined as the capacity with the largest chiller out of service, is 1000 tons. The total heating water system capacity remains 6,600,000 BTUH. After construction of the new science building is completed, the existing central plant will be operating at near maximum capacity, with no redundancy in the chilled water or heating water system equipment.

Campus Thermal Utility Distribution System

There are two sets of existing thermal utility lines exiting the central plant which consist of chilled water and heating water piping. One set of lines exits the plant to the north and according to operators are abandoned. Another set of 12" chilled water lines and 8" heating water lines exits the plant to the west and ties into the campus distribution system between the Administration building and the Classroom and Lab Building. Each set of 12" chilled water lines has a distribution capacity of about 2,500 GPM and the 8" heating water lines have a capacity of approximately 1000 GPM.

A new set of 14" diameter chilled water lines with a capacity of 3,500 GPM is being installed as part of the new science building and will exit the plant from the east. A new set of 8" heating water lines is being installed to run parallel to the new chilled water piping. These new chilled water and heating water lines will serve the new science building and provide for future expansion.

There is a bottleneck in the existing chilled water distribution lines located where the 8" lines are reduced to 6" diameter lines immediately downstream of the classroom lab building. As a result, the differential pressures at buildings connected to the distribution system downstream of this bottleneck operate at a much lower differential pressure.

New Central Plant

The proposed building expansion will add to the current thermal utility demand of the Mitchell campus. Since there is no additional capacity available in the existing central, a new central plant will be required. The proposed location for this plant is on the northeast side of the campus. The new central plant should be air conditioned to reduce maintenance requirements and extend the useful life of equipment in the plant.

Installing three (3) 900 ton chillers will increase the firm chiller capacity of

the campus from 1000 tons to 3700 tons, which will be sufficient to meet the additional chilled water demand. The central plant will also require three (3) new cooling towers to operate with the new chillers. The heating water system will require approximately 17,500,000 BTUH of capacity. Installing four (4) 175 boiler horsepower boilers with an output capacity of 5858 BTUH each will yield a firm capacity of 17,500,000 BTUH.

Thermal Utility Distribution System

Chilled water will be distributed from the new central plant with direct buried 20" diameter ductile iron piping for the chilled water lines. 12" diameter direct buried ductile iron piping will be required for heating water distribution piping. The 20" chilled water lines and 12" heating water lines exiting the plant should be routed for connection to the existing thermal lines near the new science building.

Hydraulic performance of the thermal distribution system can be improved by routing an additional set of lines for connection to the existing distribution piping at the PE Building. Installing a set of 14" chilled water and 8" heating water branch lines tapped off the main lines exiting the new central plant will result in a completed hydraulic loop for the campus thermal utility distribution system. A hydraulic loop will result in increased differential pressures at buildings which are located farther away from the existing central plant. The existing bottleneck in the chilled water lines near the classroom lab building will also be relieved by routing the additional 14" diameter chilled water branch.

Building Names	Sq.Ft	Projected peak Cooling Load (Tons)	Projected Peak Heating Load (Btu/h)
Academic / Research 1	70,000	394	2,677,500
Academic / Research 2	110,000	619	4,207,500
Academic / Research 3	60,000	338	2,295,000
Academic / Research 4	80,000	450	3,060,000
Academic / Research 5	90,000	506	3,442,500
Admin	9,000	31	157,500
Auditorium	16,000	55	280,000
Library Expansion	35,000	120	612,500
Student Center Expansion	8,000	28	140,000
Student Center Expansion	16,000	55	280,000
PE Building Expansion	21,000	72	367,500
Total	515,000	2,667	17,520,000

Table: Proposed campus building expansion with projected heating and cooling demand for each building

Engineering: Thermal Energy





Domestic water

Engineering: Water, Sewer, and Storm Water

Based on meetings at TAMUG on March 11, 2008, the staff has indicated that the existing wastewater treatment plant is a 200,000 GPD plant and currently operating with an average daily flow of 60,000 GPD. The plant is currently operating at 30%. Rules promulgated by the Texas Commission of Environmental Quality require that a plant expansion must be in design if the capacity reaches 75%. The staff noted that the plant is getting old. It is assumed that maintenance on the plant is likely to increase.

These improvements are expected to create an additional wastewater demand of approximately 179,000 GPD. This is an approximate increase of 300% of existing flows and over the allowable treatment capacity. Maximum treatment flow at the 75% requirement will require a treatment facility of 320,000 GPD at the end of proposed development. An assessment should be made on the current condition of the existing wastewater treatment plant, its ability to be expanded and its ability to meet probable future treatment requirements. An assessment should include consideration for time of the expansion or replacement and potential reuse of treated effluent.

Due to the increase of the treated flow, the outfall of this system will likely to require upgrading. The current TCEQ permit will require modifications. Adding another discharge point will not be acceptable. Modifying an existing permit can take up to 6 months for approvals. This needs to be considered when determining project schedules.

Also, several existing utilities will require relocation. Since the utilities were built as the campus expanded, they do not follow a master-planned utility corridor. The placement of the future buildings and the expansions of existing buildings will provide corridors for proposed utility services and those existing utilities that require relocation.



Storm water

Demand calculations for water and wastewater were made on the provided square footages, capacity and number of beds given by Ford, Powell & Carson. The water and wastewater demands were calculated using the City of Houston Planning & Operations Support Division Discharge Criteria Sheet. This criterion gives a "Service Unit Equivalency" based on the type of development that can be converted to an estimated flow rate for water and sanitary sewer demand.

- 1) 17,000 GSF auditorium capacity of 800 seats
- 2) 450,000 GSF of teaching, library, office and research space
- 3) 890 beds for school residence
- 4) 29,000 GSF student activity center
- 5) 31,000 GSF PE building – Gymnasium

The following table shows the calculated demand for water and wastewater for each new facility.

Number	Quantity	SUE	Sewer GPD	Water GPD
1)	800 seats	0.03170/seat	7,990 gpd	12,430 gpd
2)	450,000 gsf	0.000335/sf	47,490 gpd	73,870 gpd
3)	890 capita	0.317/capita	88,880 gpd	138,250 gpd
4)	29,000 gsf	0.0025/sf	22,840 gpd	35,530 gpd
5)	31,000 gsf	0.00121/sf	11,820 gpd	18,380 gpd
TOTAL			179,020 gpd	278,460 gpd



Natural gas

Engineering: Water, Sewer, and Storm Water



Sanitary sewer

As noted in the existing conditions report, the infrastructure to support the voice and data networks at TAMUG consists of a variety of signal pathways including copper campus (inter-building) backbone cable and single mode/multimode fiber optic backbone cables that run throughout the campus in a system of underground distribution conduit banks and sub-surface vaults for use as pull points and changes in direction of the cable. The campus is provided telephone and high speed internet service from AT&T. This service is routed across the bridge. Satellite CATV provides service for the dorms. There is no distribution of CATV beyond the dorms.

- The existing system is not reliable, scalable, or resilient, nor is there a flexible technology infrastructure for future development.
- No telecommunications standards exist.
- The existing infrastructure does not incorporate redundant routing, back-up systems or preventative methodologies.
- Existing duct banks have reached capacity, are not properly protected, and have suffered numerous breakages.
- An accurate document is not available that shows the number of conduits in the duct bank and how each is populated.
- The majority of the installed fiber optic cable is multimode and will not address future bandwidth requirements. Single mode fiber is required for today's needs and to ensure adequate bandwidth into the future.

When extending this network into the areas on campus planned for expansion, many factors need to be considered. Some of the issues that must be considered are capacity for current and future operations, the routing of the systems along rights-of-way, locations of the maintenance points, survivability, conduit identification, and as-built records.

Attempting to predict what types of media will be available years into the future is difficult, if not impossible. Because of this, the best way to prepare for future requirements is to design a system of pathways that can be re-used many times over and to establish a process for keeping record drawings up to date. The expense of setting up a system of pathways that can be evacuated and repopulated with the current technology will be easily recovered in future savings by not having pay to disrupt hardened surfaces and established landscaping to place new conduits. It is recommended that a budget for updating the permanent records for existing conduit be added as a requirement, as well as the completed as-built drawings for all expansion areas.

The type of backbone media placed into the conduit network will affect the types of services that can be distributed. It is recommended that at a minimum, capacity be planned for single mode fiber, 62.5 um multi-mode fiber, 50 um multi-mode fiber, and multi-pair copper cables. To achieve this, the campus wide conduit distribution consisting of four four-inch conduits to each building must be expanded in congested areas. One scenario

for the allocation of conduits into each building would be one of the four conduits would be filled with six cells of fabric inner-duct for fiber cabling; one conduit would be for current voice services and one for use by the building maintenance and security departments, with the remaining conduit kept as a spare or as a pathway for other new buildings.

Additionally, the pathways would be designed using current best practices by not having more than 180 degrees of bends between pulling points and not having any outside runs longer than 500 feet without a pulling point. This practice will assure that the system of conduits may be re-used for future media types. Plugging any unused conduits and filling the voids in the other conduits are other important maintenance practices. A system of labels based on ANSI/TIA/EIA 606A identifying what each conduit is allocated for along with the "to" and "from" information are extremely beneficial for disaster recovery operations and to facilitate ongoing maintenance. A commitment to the importance of correctly designing and maintaining a system of campus backbone pathways and communicating to decision makers how much this kind of technology infrastructure adds to the value of a viable infrastructure is a must.

Horizontal distribution consists of extending the campus wide services to the individual work areas and maintenance points. This is done from a location in the building established for such purposes. These locations may be referred to as an Information Technology (IT) room, Telecommunications Room (TR), Building Distributor (BD), as well as many others. The current TIA/EIA standards are moving towards the international designation of 'Building Distributor' - BD. This naming convention alludes to the fact that multiple services that require horizontal distribution may be able to be collocated within this one room. With this understanding, the BD should be sized accordingly. Industry standards include guidelines based on the number of square feet in the served area and the work area density. These guidelines may be customized to fit the specific educational needs of the campus.

Engineering: Telecommunications

Building Space Requirements

Telecommunication rooms must be located on the floor plan such that no cable run to any work area will exceed a cable distance of 295 feet. Due to the extreme sensitivity of the newer high-speed copper UTP cables (Category 6) and the real life limitations of installing the cabling at a “safe” distance from power cabling and conduits, it is recommended that the total linear cable distance be kept to 270 feet. What this practice will help do is mitigate signal coupling and third harmonic disturbances on cables. In a multi-story building it is recommended that there be a minimum of one room per floor and that the rooms on the other floors in the building be stacked one on top of the other with at least three of the walls stacked.

Once the BDs are sized and located, a system of pathways leading from the BD to the individual work areas should be carefully designed. As with the campus backbone conduit network, a system of pathways should be designed that has been sized for future capacities, is accessible, and is resilient. If multiple services are to be distributed using a single pathway, it is recommended that a means of segregating the services be employed. Each pathway would be labeled with the name of the BD room of origin. To facilitate the re-use of the horizontal pathways one recommendation would be that when making changes all unused cables be removed.

Bandwidth Requirements

Technology in general, and the Internet specifically, has become an integral part of the educational experience. The TAMUG campus IT infrastructure gives students access to the wealth of information only available on the Internet. As students and staff utilize the Internet more intensively, demand for access will grow. For example, individual password-controlled e-mail accounts, and the use of these accounts to communicate with faculty for the purpose of submitting course work, places greater demands on connections to the data network and the Internet. These factors should be taken into consideration when planning current and future technology infrastructure requirements. That is, both instructional technologies and support technologies require an infrastructure that not only meets the current needs but also allows for growth and reconfiguration as needs and emphasis change.

One study has found that the bandwidth requirements of users have been doubling every three to four years. This is due to the fact that users are, in general, sending larger files both within and external to their systems. Users are also sending more of their traffic outside the campus system than previous years. The old rule was that 20 percent of network traffic moved across the backbone and 80 percent of network traffic was local. This rule has done a 180-degree turn: today 80 percent of network traffic moves across the backbone or into the World Wide Web and only 20 percent of network traffic is local. This is due to the collaborative nature of education. It is clear that the more traffic that is sent externally to the system, the

greater the bandwidth capacity needs to be for the backbone cabling. The external traffic is typically emails with attachments. In past years a simple email text message was the predominant communication. Now, email text and one or more attachments make up a larger percentage of the regular traffic. The attached files are also growing larger and larger.

It is recommended that an assessment of the different campus departments’ inter- and intra-campus connections be conducted. This could be accomplished automatically from a network operations center that can monitor network utilization. Once the bandwidth analysis is completed and network utilization is known, equipment may be upgraded that can allocate idle bandwidth to the services that have a greater demand. This will provide enhanced services and more efficient use of resources.

Campus Technology Overview

Telecommunications infrastructure serves many uses today. In addition to the traditional use for data communications, the technology infrastructure serves video, security, wireless and ultimately voice communications. The impact of the technology infrastructure is far-reaching. Every single member of the faculty, staff and student body requires it to function properly and reliably.

Network Topology - Data

The main hub for data and voice services is the Classroom Lab Building (CLB) building located in the center of the campus. These services are distributed via multi-fiber backbone cables. The network topology is a mixture of direct and distributed services.

Network Topology - Voice Telecommunications

A Cisco switch provides voice over internet protocol (VoIP) from the CLB and serves the entire existing voice telecommunication needs.

Some of the existing copper cables that once served voice analog circuits (POTS) are now being used for fax and other ancillary services. Some or the majority of this copper cabling could be removed to free up existing conduit space. This would free up a significant portion of the currently occupied conduit system, thus removing the requirement for adding new conduits. This process should be phased in gradually to minimize impact on budgets, and the need to continue using copper lines for certain devices (including credit card readers, fax machines, and some alarm circuits) should be addressed.

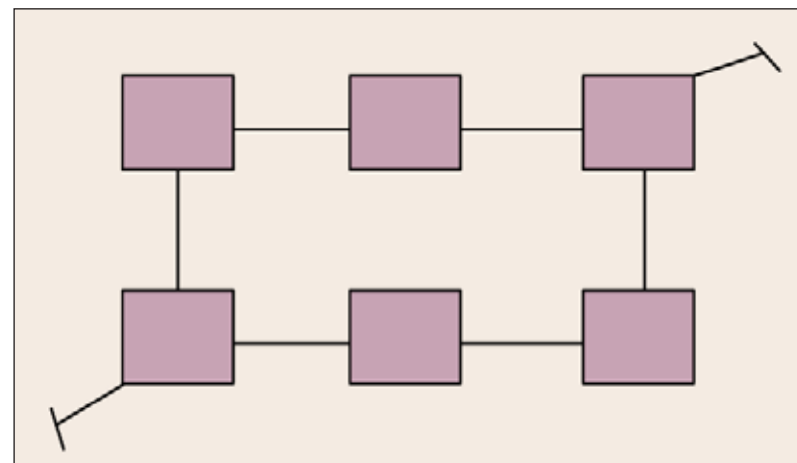
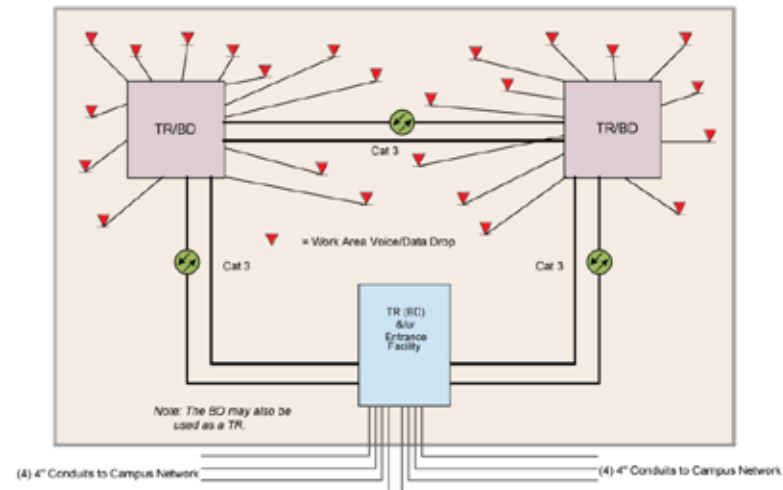
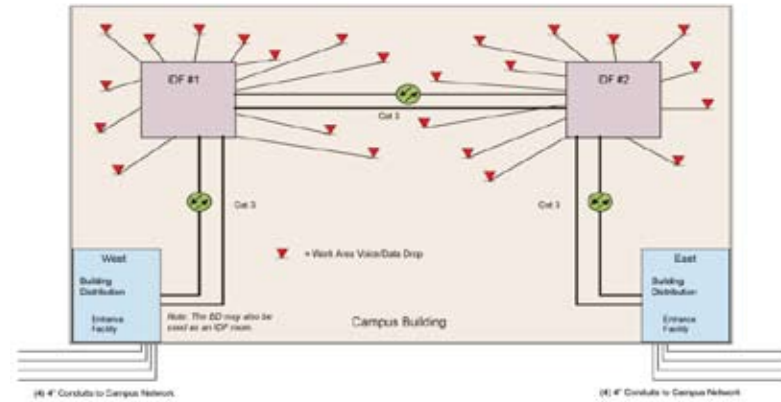
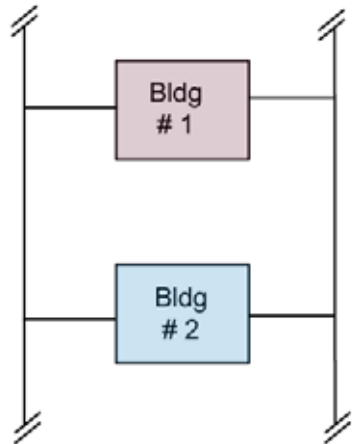

Engineering: Telecommunications

Security

During interviews conducted with TAMUG administration and staff, security was mentioned as an area which should receive more attention. The ability to restrict access, change levels of access at any access point, and to monitor any area is becoming more of a necessity than a luxury. Potential and real loss of expensive equipment, especially notebook computers from unoccupied classrooms (computer labs), points to the desirability of increasing the number of areas that require controlled access. Some areas are already being considered for this increased control. A number of sensitive locations suggest the deployment of card-key access devices. (The use of biometric devices for access control has been ruled out at this time). These include any area where cash is handled; areas where records are retained; computer labs, classrooms and storage rooms where valuable equipment is stored; main communication rooms and telecommunication rooms where networking equipment is installed; server rooms where ITS servers are housed; and main entrances to buildings.

Many of the access control points for buildings are standalone. Ideally this would be networked for single point administration (thus removing the need for staff to go to each door to update with current requirements).

Access devices require that infrastructure be added where these devices will be located (in door hardware and conduits to junction boxes near the doors). This should be included in building and campus planning to avoid having to add these devices after all other infrastructure cabling has been completed.

Surveillance with video cameras occurs in some locations on campus. Some of these cameras are connected to tape backups, while other locations are not recorded. Digital video recorders will be considered in all new construction as well as possibly in some existing buildings. As the new building infrastructure is designed, attention must be given to additional cabling needed to expand the coverage of the video security system within the building and connectivity to the central security monitoring station. It should be noted that analog video signals require large blocks of bandwidth. Only eight to ten channels per single mode fiber pair are available. If analog video is contemplated, the bandwidth intensive nature of this application will need to be considered vis-à-vis the number of fiber pairs available. While the equipment is more expensive, digital video applications are much less bandwidth intensive.

Network Redundancy

Information technology requires careful attention to redundancy in all areas to avoid costly outages and information loss. Security requirements are also now calling for redundant physical pathways and cables. Areas requiring redundancy include physical pathways, the network equipment itself, and information backup.

At the present time there are areas of conduit congestion where no conduit pathways are available. This would mean allocating funds for strategic upgrades and maintenance of the pathway system, or as noted above the removal of existing copper infrastructure. A discussion of this subject is in the section entitled "Planned Pathway Growth."

Planned Pathway Growth

In conjunction with the plan for campus building growth, corridors for utility service have been allocated. Included in this system are the pathways for voice and data communications. As noted in the assessment document, the corridors for communications run both east-west and north-south – a proposed new corridor will run north-south through the middle of campus. These duct banks will need to be of sufficient size to accommodate both planned and unforeseen growth.

Overview

The existing communications vault and conduit system on campus is a number of years old and as such a significant number of the conduits are full. A complete inventory of this system should be made in order to assess its capacity to adding cabling for future building on campus.

The TAMUG campus has some physical network redundancy today, but it is not considered adequate. For example, the one Internet connection to the campus is over the one bridge connecting the campus to the mainland. If this is damaged, the whole campus would go down. The ideal redundant system is a ring of fiber optic and copper cable so that a failure in one segment would not cause a network outage. This approach will provide network redundancy and must be included in all campus plans. The approach is also costly. One estimate per linear foot for a four four-inch conduit duct bank is \$110, with the cost of manholes/vaults priced from \$3,500 to \$8,000 each. Independent paths from WAN entry points in the CLB and the Science Building to each campus building should be investigated.

As outlined in other sections of this document, the major areas of contemplated expansion are to the north and south for classroom and housing. To provide communications services to these areas a determination will need to be made on the availability of conduits in the existing conduit system and their availability to have cables added.

In the event that the existing conduit bank is too congested to extend to a new area via the existing system, an alternative routing must be found. One suggestion would be to install a major fiber trunk from the data and voice center in the CLB through the various intervening buildings to the start of the new conduit and vault system for developing areas.

New infrastructure will be installed in the new facilities. Even though these new facilities will be constructed to current standards, they will ultimately



Telecommunications infrastructure

Engineering: Telecommunications



Existing telecommunications infrastructure

be connected back to the existing backbone cabling. Distances are therefore also an important issue. When the new infrastructure is designed, careful consideration should be given to installing adequately sized single-mode fiber cable for future bandwidth increases. The entire backbone of the TAMUG campus will be only as secure and robust as the weakest link.

Backup of Information

Any robust system for insuring network integrity will also include some type of information backup. A storage area network (SAN) to protect and backup important data or other means of information backup must be part of the budgeting for campus growth.

Disaster Recovery

TAMUG has a disaster recovery plan, with an overall administrator, and section chiefs who are in charge of their areas. With the dependence of teaching and research on the technology infrastructure, it is paramount that the campus maintains these plans. It is recommended that they be reviewed every year and updated as needed. The design approach for the pathway system would be to create a system of redundant routes and an infrastructure that is flexible and resilient. One benefit of this structured design approach is that the system can be rapidly and easily reconfigured should the loss of a pathway or BD occur. By placing spare capacity and

having redundant paths to serve the campus buildings, recovering from a disaster of this type is made much easier. From an information recovery standpoint, the plans should include procedures for on- and off-site storage of critical data and the regular updating of the files. A plan is only as good as the design and the implementation. Therefore it would be prudent to allocate funds for the implementation and maintenance of the plans in the normal campus budget cycle.

Regulated Power

Computer-based systems need clean power. Computers, point-of-sale equipment, telecommunications and building management systems all rely on semiconductors to operate. Semiconductors perform by processing electric signals of less than a few volts each. Transient voltage disturbances confuse that process and data may be lost or corrupted, with IP packets garbled and processes stopped. Systems would then need to be reset. In the worst case, electrical overstress can destroy or degrade semiconductor material. The results are increasingly unreliable operation or seemingly random, sudden failures.

Until recently, clean power requirements have not been a part of overall planning. New construction requirements should specify reliable power that is free from voltage drops over a certain percentage, is free from disturbing harmonics, and is consistent. To ensure power delivery within acceptable limits for IT infrastructure, the consideration of universal power supplies, power distribution units, and generators would be necessary. As the cost for these items is generally high, and as they are usually in competition for limited resources, there is a tendency to limit their implementation. It is therefore recommended that they be considered in a strategic sense (included in budget planning) and installed only in main communication and server rooms, with individual circuits for critical electronics in floor serving telecom rooms.

With the advent of audio-visual systems becoming more and more digitally (IP) based, more and more attention must be paid to clean power and the grounding of these systems. Isolated grounding systems must be considered where the audio-visual systems contain digital signal processors. Put succinctly, a small amount of garbage in can result in a lot of garbage out, which can cause significant and unwanted noise on speaker systems.

Dry Fire Suppression

Due to the high cost of dry fire suppression systems (e.g. FM200), it is recommended that they be considered and installed only in data centers and possibly server rooms.

Wireless LAN Infrastructure

Wireless LAN connectivity is a technology that continues to evolve. The demand for wireless connectivity will constantly increase as more and more faculty, staff, and students acquire notebook computers with the ex-

pectation and desire to have them function anywhere, at any time. Today, student access to network resources requires a wired data connection in many areas. A wireless LAN infrastructure will allow the students and faculty to work with greater flexibility and freedom. TAMUG has plans that call for the implementation of wireless connectivity in all future buildings.

These access points do not need to be deployed immediately. The deployment of wireless access points can be accomplished as the coverage is needed. It is important that the infrastructure be installed now to minimize the cost. The incremental cost to add this infrastructure is small compared to the cost of adding it later.

Telecommunications Infrastructure Programming Goals

The following goals are considered desirable by TAMUG IT staff and are put forward for campus planners to consider:

- Provide a reliable, scalable, resilient, and flexible technology infrastructure
- Be a next-generation solution and have the ability to be expandable and handle new types of services and features
- Accommodate new users in an easy, affordable manner
- Be a scalable centrally distributed solution
- Day to day maintenance issues as well as the moves adds and changes required for the operations personnel should be a priority
- The technology will be problem free and transparent for the end users
- Incorporate redundant routing, back-up systems and preventative methodologies in the design of the campus infrastructure
- Minimize the effects of integration of the new facilities
- Evaluate and understand the impact of the construction on existing facilities

Cost Burden of Services

Charges for Internet access and bandwidth usage generally are an increasing burden for any campus. If not already in place, one might consider that department usage be billed to the department. For example, video conferencing and distance learning are practical and useful adjuncts to the university's teaching and research goals, and they are bandwidth intensive. Allocating costs by departments for bandwidth usage is one way to understand where needs are greatest, and creates an incentive to the users to monitor their needs.

The migration to IP-based video will move more traffic on to the TAMUG network. Circuits must be maintained for off-site connections. It may be possible to share the circuits during idle times with other users. It is always more efficient to have one large circuit shared by many users than to have multiple circuits used by one or a few users. Redundancy between campus buildings today is a weakness in the existing network design. This is the result of the lack of a focused inclusion of IT infrastructure requirements in the ongoing campus building cycle.

Fund allocation for IT needs has traditionally come as an afterthought. A reorientation of the budgeting process on a strategic level is a must for adequate planning and management of resources available to the campus as a whole.

Finally, traffic studies should be conducted for circuit utilization on a regular basis to determine if the correct total campus bandwidth is adequate. The campus might consider charge-back to specific departments/schools for their portion of the overall costs.

Engineering: Telecommunications

Recommendations for the Use of This Master Plan Document

Creation of Technology Infrastructure Construction Guidelines and Standards

It is recommended that TAMUG create a set of system-wide design criteria for technology infrastructure that would be integrated with TAMUG's specific campus needs. These standards should be based on EIA/TIA standards and should provide for a consistent application of technology infrastructure as new buildings are designed. These standards should be comprehensive and should be regarded as a living document that must be periodically reviewed and updated. This set of standards would be used as a blueprint and protocol for vendors, contractors, consultants, planners, etc. It would include all aspects of the TAMUG communications infrastructure (voice, video, data, broadband television, security, and building management systems). The document should be submitted for approval and acceptance by college administration. Following the document's acceptance, it should be included as part of the campus's general construction guidelines as a required part of any future construction project. Once updated, they should be posted on campus web pages.

Once approved, this master plan document will contain information that can be valuable to the creation of construction guidelines and standards for the campus technology infrastructure. It is recommended that it be used in its entirety and not have sections used without reference to the whole document. It should be considered a living document that must maintain its relevancy to the TAMUG changing environment. It is also recommended that procedures be established for periodic review and updating as conditions within TAMUG change and as standards evolve.

Utilize the most recent editions of the following:

Codes

International Building Code (IBC)
NFPA, including the Life Safety Code
National Electrical Code (NEC/NFPA 70)
National Electrical Safety Code (NES IEEE C2-2002)
IEEE Std. 1100-1999 Recommended Practice for Powering and Grounding Sensitive Electronic Equipment
Uniform Fire Code
Local Codes, amendments, and ordinances
Americans with Disabilities Act Guidelines

Standards

ANSI/TIA/EIA-568-B.2: Commercial Building Telecommunications Cabling Standard, Part 1: General Requirements
ANSI/TIA/EIA-568-B.2: Commercial Building Telecommunications Cabling Standard, Part 2: Balanced Twisted-Pair Cabling Components

ANSI/TIA/EIA-568- B.3 Part 3: Optical Fiber Cabling Components Standard

ANSI/TIA/EIA-455-A: Standard Test Procedures for Fiber Optic Cables

ANSI/CEA S83-596: Fiber Optic Premises Distribution Cable

ANSI/TIA/EIA-526-7: Optical Power Loss Measurements of Installed Single Mode Fiber Cable Plant-OFSTP-7

ANSI/TIA/EIA-526-14-A: Optical Power Loss Measurements of Installed Multi Mode Fiber Cable Plant-OFSTP-14A

ANSI/TIA/EIA-569-A: Commercial Building Standards for Telecommunications Pathways and Spaces

ANSI/TIA/EIA-60A6: The Administration Standard for the Telecommunications Infrastructure of Commercial Buildings

ANSI/TIA/EIA-607A: Commercial Building Grounding and Bonding Requirements for Telecommunications

TIA/EIA 758-April: Customer-Outside Plant Telecommunications Cabling Standard

ATSM Standards

Texas Accessibility Standards (TAS)

Design Team

Architecture and Master Planning: Ford, Powell & Carson Architects & Planners, Inc.

Boone Powell
Jay Louden

MEP Engineering: Shah Smith and Associates

Doug Garrison
Bryan Bagley
Jeff Bolander

Civil Engineering: Klotz and Associates

Bill Schoch
Gene Coronado
Ty Turner

Signage and Wayfinding: fd2s, Inc.

Curtis Roberts
Lon Calvert
Samantha Segar

Landscape Design: Clark Condon Associates

Paul Weathers

Telecommunications: DataCom Design Group, Inc.

Craig Gilian
Clayton Sellers
Adam Dickerson

Renderings: Jim Arp Architectural Renderings

Jim Arp

Acknowledgements

Texas A&M University at Galveston

R. Bowen Loftin, Ph.D., VP and CEO
Rodney P. McClendon, JD, Ph.D., Exec. Assoc. VP and COO
Brad McGonagle, Ph.D., Assistant VP for Administration
William Seitz, Ph.D., Assoc. VP for Research and Grad. Studies
Donna Lang, E.Ed., Assoc. VP for Enrollment Mgmt. and Outreach
Gilbert Rowe, Ph.D., Assoc. VP Academic Affairs and CAO
Grant Shallenberger, Asst. VP of Student Affairs and Auxiliary Services
Bill Hearn, TMA
Tammy Lobaugh, Physical Plant Director
Steve Conway, Director, Computing and Information Services
William Pickavance, Interim Superintendent TMA
Susan Lee, Assoc. VP Finance
Karen Bigley, Director of Media Relations and Communications
Cherie Coffman, Exec. Assistant to the VP
Taryn Cornelius, Graphic Designer
Pat Hebert, Facilities Coordinator

Texas A&M System

Vergel L. Gay, Jr., AIA, Managing Director, Facil. Planning and Construction
Russell Wallace, Director of Project Delivery
